

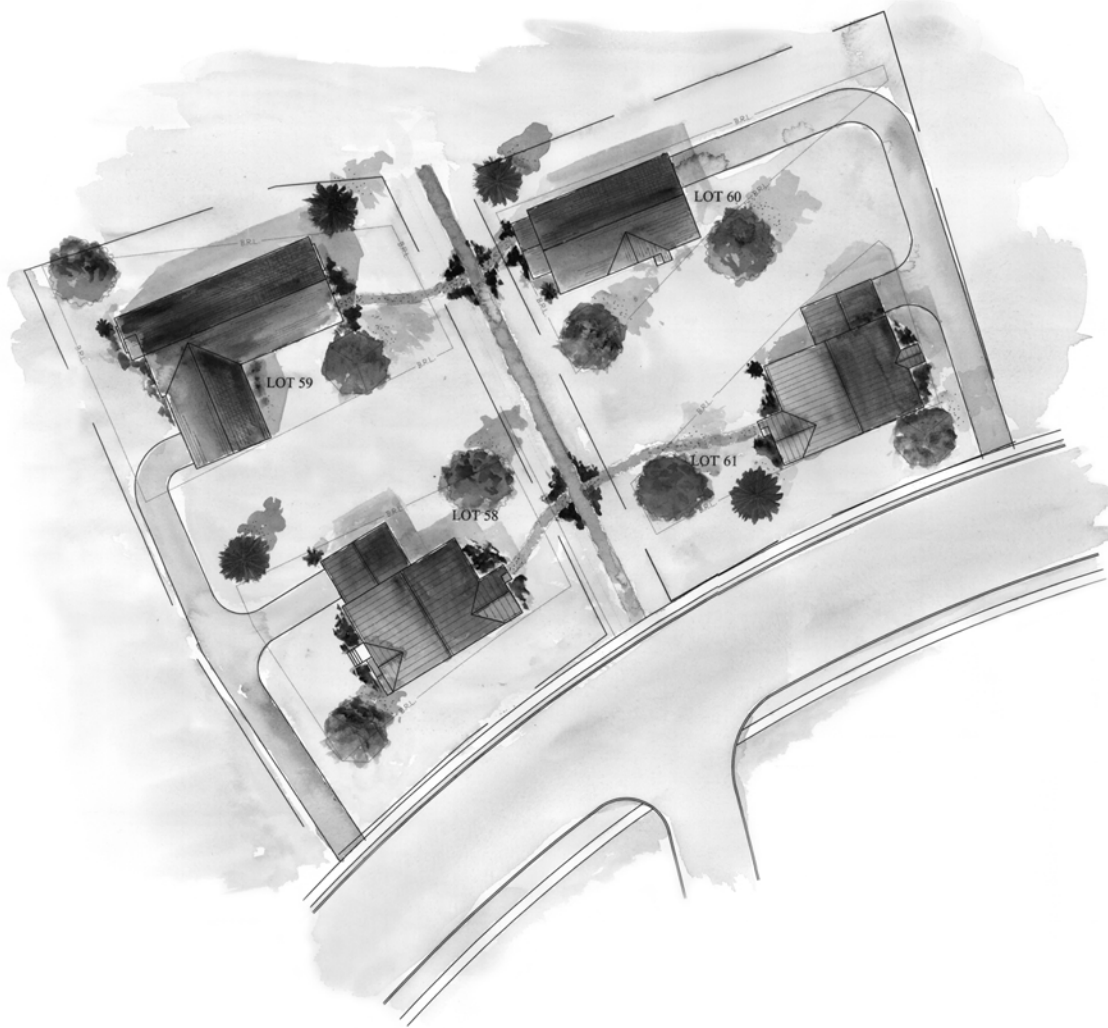

U.S. Department of Housing and Urban Development
Office of Policy Development and Research

The Practice of Low Impact Development



PATH (Partnership for Advancing Technology in Housing) is a private/public effort to develop, demonstrate, and gain widespread market acceptance for the "Next Generation" of American housing. Through the use of new or innovative technologies, the goal of PATH is to improve the quality, durability, environmental efficiency, and affordability of tomorrow's homes.

PATH is managed and supported by the U.S. Department of Housing and Urban Development (HUD). In addition, all federal agencies that engage in housing research and technology development are PATH Partners, including the Departments of Energy, Commerce, and Agriculture, as well as the Environmental Protection Agency (EPA) and the Federal Emergency Management Agency (FEMA). State and local governments and other participants from the public sector are also partners in PATH. Product manufacturers, home builders, insurance companies, and lenders represent private industry in the PATH Partnership.

To learn more about PATH, please contact



451 7th Street, SW
Washington, DC 20410
202-708-4277 (phone)
202-708-5873 (fax)
e-mail: pathnet@pathnet.org
website: www.pathnet.org

Visit PD&R's website

www.huduser.org

to find this report and others sponsored by
HUD's Office of Policy Development and Research (PD&R).

Other services of HUD USER, PD&R's Research Information Service, include listservs; special interest, bimonthly publications (best practices, significant studies from other sources); access to public use databases; and a hotline 1-800-245-2691 for help accessing the information you need.

The Practice of Low Impact Development

Prepared for:

U.S. Department of Housing and Urban Development
Office of Policy Development and Research
Washington, D.C.

By:

NAHB Research Center, Inc.
Upper Marlboro, Maryland

Contract No. H-21314CA

July 2003

ACKNOWLEDGEMENTS

This report was prepared by the NAHB Research Center, Inc. under sponsorship of the U.S. Department of Housing and Urban Development (HUD). The principal authors are Douglas M. Nataluk and Richard Dooley. The authors would like to express gratitude to Carol Soble, Donna Woodhurst, Jeannie Leggett Sikora, Michael Grothe, Sabra Harvey, Vicki Gaines (NAHB Research Center), Ed Tombari, Marolyn Parson, and Susan Asmus (NAHB) for their significant contribution to this work, and Jay Crandell (Applied Residential Engineering Services) for his technical review. Special appreciation is extended to Edwin Stromberg and William Freeborne of HUD for their guidance and assistance throughout the project.

Special recognition is extended to our Expert Review Group for providing input to the authors at the beginning of the project. The group members include:

Don Alexander	Virginia Department of Health
Debbie Bassert	National Association of Home Builders
Anthony Giancola	National Association County Engineers
Robert Goo	U.S. Environmental Protection Agency
Mark Hinshaw	LMN Architects
John McHenry	National Association of Home Builders
Joe Molinaro	National Association of Realtors
David O'Neill	Urban Land Institute
Mike Sands	Prairie Crossing
Jim Smalley	National Fire Protection Association
Bill Warkentin	Warkentin Associates
Neil Weinstein	Low Impact Development Center

DISCLAIMER

While the information in this document is believed to be accurate, neither the authors, nor reviewers, nor the U.S. Department of Housing and Urban Development of the U.S. Government, nor the National Association of Home Builders, nor the NAHB Research Center, Inc., nor any of their employees or representatives make any warranty, guarantee, or representation, expressed or implied, with respect to the accuracy, effectiveness, or usefulness of any information, method, or material in this document, nor assumes any liability for the use of any information, methods, or materials, disclosed herein, or for damages arising from such use. The U.S. Government does not endorse any producers or manufacturers represented within this document. Trade and manufacturers' names appear herein solely because they are considered essential to the contents of this report.

TABLE OF CONTENTS

PREFACE.....	vii
EXECUTIVE SUMMARY	ix
INTRODUCTION	1
SCOPE	3
HOW TO USE THIS DOCUMENT.....	5
AUDIENCE	7
PART I: PROJECT PLANNING AND DESIGN	9
Section 1 – Low Impact Development (LID) Primer	11
1.1 Overview.....	13
1.2 Benefits of Low Impact Development.....	13
1.3 Goals of Low Impact Development.....	13
1.4 Challenges to Using Low Impact Development	15
1.5 Planning for Low Impact Development.....	16
1.5.1 Collaboration.....	17
1.5.2 Ordinance Review/Outreach.....	18
1.5.3 Site Analysis	19
1.6 Site Design for Low Impact Development	21
1.6.1 Site Area Classification.....	23
1.6.2 Circulation Design	23
1.6.3 Infrastructure and Natural Resources Design	24
PART II: PROJECT TOOLS /REFERENCES	25
Section 2 – Storm Water Management	27
2.1 Introduction.....	29
2.2 Conventional Approaches to Storm Water Management	31
2.3 Alternatives to Conventional Systems	32
2.3.1 Infiltration Systems.....	33
2.3.2 Filtering Systems	39
2.3.3 Conveyance Systems	43
2.3.4 Other Systems	43
2.4 Additional Resources.....	44

Section 3 – Wastewater Treatment	51
3.1 Introduction.....	53
3.1.1 Environmental Issues	55
3.1.2 Cost Issues	56
3.1.3 Regulatory Issues	57
3.1.4 General Performance Standards.....	57
3.2 Conventional Approaches to Wastewater Treatment	58
3.3 Alternatives to Conventional Systems	61
3.3.1 Process for Identifying Potential On-site Wastewater Treatment System Alternatives	62
3.3.2 Sand Filters	66
3.3.3 Mound.....	67
3.3.4 Trickling Filter.....	68
3.3.5 Evapotranspiration	69
3.3.6 Low-Pressure	70
3.3.7 Aerobic Systems	71
3.3.8 Proprietary Systems	72
3.4 Additional Resources.....	73
 Section 4 – Circulation and Design	 77
4.1 Introduction.....	79
4.1.1 Environmental Benefits	80
4.1.2 Economic Benefits.....	81
4.2 Conventional Approaches to Circulation and Design.....	81
4.2.1 Rights-of-Way.....	81
4.2.2 Streets.....	82
4.2.3 Intersections	83
4.2.4 Cul-de-sacs.....	84
4.2.5 Parking	85
4.3 Alternative Approaches to Circulation and Design	86
4.3.1 Alternative Design Considerations	86
4.3.2 Alternative Street Types	89
4.3.3 Shared Driveways	91
4.3.4 Sidewalks and Paths.....	91
4.3.5 Alternative Pavements	92
4.3.6 Alternative Lot Shapes.....	93
4.4 Additional Resources.....	95
 APPENDIX A - Glossary	 99
APPENDIX B – Case Studies.....	103
APPENDIX C - References	113
APPENDIX D – 1993 Publication’s Table of Contents	119

LIST OF TABLES

TABLE 1.	Overview of Document.....	5
TABLE 2.	Benefits to Stakeholders	14
TABLE 3.	Comparison Between Low Impact Development and Traditional Land Development Processes	17
TABLE 4.	Items to Consider	18
TABLE 5.	Site Analysis Considerations for Technologies Discussed in Part I.....	19
TABLE 6.	Sources of Information	20
TABLE 7.	Storm Water Management Options	31
TABLE 8.	Types of Ponds Currently Used in Residential Developments.....	32
TABLE 9.	Cost Comparison: Closed (Conventional) System Versus Bioretention ...	33
TABLE 10.	Reported Pollutant Removal Efficiency of Best Management Practice (BMP).....	34
TABLE 11.	Wastewater Management Options	53
TABLE 12.	Wastewater Management Objectives.....	54
TABLE 13.	Common Reasons for Septic System Failure.....	55
TABLE 14.	On-site Wastewater Treatment System Alternatives	61
TABLE 15.	Factors to Consider when Evaluating On-site Wastewater Treatment Systems	63
TABLE 16.	Secondary Treatment	67
TABLE 17.	Typical Street Construction Costs	80
TABLE 18.	Circulation and Design Objectives	80
TABLE 19.	Unit Costs Estimates of Typical Subdivision Development.....	81
TABLE 20.	Minimum Street Widths for Fire Vehicles.....	82
TABLE 21.	Suggested Pavement Widths.....	83
TABLE 22.	Recommended Ranges for Curb Radii	83
TABLE 23.	Driveway Considerations for Reducing Impervious Area.....	91
TABLE 24.	Sidewalk Considerations for Impervious Area.....	92
TABLE 25.	Functional Comparison of Various Types of Alternative Pavements	93
TABLE 26.	Cost Comparison of Conventional Storm Water System versus Bioretention.....	112

LIST OF FIGURES

FIGURE 1.	Low Impact Development Site Design.....	22
FIGURE 2.	Infiltration Trench.....	35
FIGURE 3.	Dry Well.....	36
FIGURE 4.	Typical Bioretention Area.....	38
FIGURE 5.	Level Spreader	39
FIGURE 6.	Typical Grass Filter Strip.....	40
FIGURE 7.	Exfiltration Trench/Dry Swales	41
FIGURE 8.	Storm Water Wetlands.....	42
FIGURE 9.	Rain Barrels	44
FIGURE 10.	How Homes Handle Wastewater	54
FIGURE 11.	Overview of Parties Interested in Wastewater Treatment Decision Making.....	65
FIGURE 12.	Typical Cross-section of an Intermittent Sand Filter	66
FIGURE 13.	Typical Recirculating Sand Filter System	67
FIGURE 14.	Schematic of a Wisconsin Mound System.....	68
FIGURE 15.	Schematic of a Trickling Filter	69
FIGURE 16.	Cross-section of a Typical Evapotranspiration Bed.....	70
FIGURE 17.	Low-pressure Pipe System.....	71
FIGURE 18.	Standard Cul-de-sac	84
FIGURE 19.	Standard Bioretention Cul-de-sac	84
FIGURE 20.	Standard “T” Turnaround	85
FIGURE 21.	Standard Loop Turnaround.....	85
FIGURE 22.	Street Layout Examples	87
FIGURE 23.	A Comparison of Queuing Streets versus Traditional Streets	90
FIGURE 24.	Alternative Lot Designs	94
FIGURE 25.	Evaluation Process for Comparing Collection and On-site Wastewater Treatment System Alternatives.....	109

PREFACE

This U.S. Department of Housing and Urban Development (HUD) document, *The Practice of Low Impact Development (LID)*, is intended to assist the housing industry during the land development process. It complements the 1993 HUD publication *Model Land Development Standards and Accompanying Model State Enabling Legislation*, which simultaneously promoted safe, high-quality housing and eliminated needless requirements that add to a home's final cost.

The HUD Office of Policy Development and Research (PD&R) supports the Department's overall mission of helping to create affordable housing and assisting communities with meeting their development needs. In particular, PD&R is responsible for monitoring the nation's housing needs, conducting research on significant community development issues, and providing reliable and objective analysis to our nation's policymakers. This publication underscores PD&R's commitment to delivering timely and accurate research to our nation's housing professionals.

The document focuses specifically on technologies that affect both the cost impacts and environmental issues associated with land development. It provides a brief introduction to low impact development and discusses conventional and alternative techniques and technologies that developers can integrate into their existing land development practices. By continually examining the land development process, the home building industry can continue to provide America with built environments that enhance the natural environment.

EXECUTIVE SUMMARY

Building professionals and municipal planning officials each have numerous goals and try to satisfy many needs during land development. Private developers are interested in profitable business ventures that also effectively address environmental concerns and meet regulatory requirements. Public sector officials ensure that development projects mesh with applicable zoning ordinances and help improve the surrounding community. This publication is intended to assist these groups by 1) providing basic conventional and innovative land development technology information, and 2) encouraging the amendment of existing development codes to facilitate the use of those technologies.

In an effort to help meet both groups' needs, the publication provides ways to simultaneously incorporate economic and environmental considerations into the land development process. This approach to land development, called Low Impact Development (LID), uses various land planning and design practices and technologies to simultaneously conserve and protect natural resource systems and reduce infrastructure costs. LID still allows land to be developed, but in a cost-effective manner that helps mitigate potential environmental impacts. LID is best suited for new, suburban development.

Some developers are already using some LID technologies in their projects, however this publication can help building professionals and municipal officials who are interested in learning more about LID. Lastly, developers do not have to incorporate all of the LID technologies noted herein into every development, rather, it is suggested developers carefully select the technologies appropriate to a site's unique regulatory, climatic, and topographic conditions. Some of the key LID recommendations are presented below.

Project Planning & Design

While the LID approach can result in a myriad of benefits for the developer, the municipality, and the environment, the proposed use of LID is likely to spawn questions during the development process. However, careful project planning, close collaboration with the local municipality, and education programs can minimize the challenges and effectively answer the questions.

Developers who have used LID practices and technologies have indicated that one of the keys to a successful project is to invest additional time and money in the initial planning stages of development. While this idea may be unpopular because of increased up-front costs, the expenditures are often recouped in the form of rapid home sales, enhanced community marketability, and higher lot yields.

Storm Water Management

Conventional storm water management systems rely on collection and conveyance systems to remove water safely from developed areas and to protect life, property, and health. The systems are engineered and designed according to estimates of post-development storm water flows and volumes from pervious and impervious areas.

Low impact development storm water management systems can reduce development costs through the reduction or elimination of conventional storm water conveyance and collection systems. LID systems can reduce the need for paving, curb and gutter, piping, inlet structures, and storm water ponds by treating water at its source instead of at the end of the pipe. However, developers are not the only parties to benefit from the use of LID storm water management techniques. Municipalities also benefit in the long term through reduced maintenance costs.

Wastewater Management

Wastewater can affect natural resources; all wastewater coming from a home must be sent to an effective treatment site or public treatment system in order to limit adverse environmental and health impacts. Nitrogen and phosphorus are two nutrients in wastewater that, either in excess or through cumulative effect, can adversely affect receiving waterbodies. When septic systems fail to operate as designed, excess nutrients in untreated wastewater can enter the environment.

In most cases, either municipal sewer or private on-site wastewater treatment systems (i.e., septic systems) can handle wastewater treatment needs. However, there are exceptions. For instance, in some circumstances, sewer systems cannot be used because of cost considerations; it might be too costly to run pipes long distances to link a proposed development's wastewater system to existing municipal sewer connections. In other cases, a municipality might have specific health or environmental concerns that make the use of septic systems unacceptable. Via the LID approach, developers can consider a variety of on-site wastewater treatment system options either as alternatives or enhancements to conventional septic systems. Some on-site treatment alternatives to conventional systems, such as recirculating sand filters and evapotranspiration systems, are "add-ons" to a traditional septic tank system. The additional treatment unit is connected in-line with the septic tank and provides an extra level of treatment.

Circulation & Design

As the struggle to decrease nonpoint source pollution in our nation's waters continues, municipalities have begun to reexamine the connection between circulation design and storm water management practices. New designs for streets, sidewalks, and driveways can maintain the functions of circulation while helping to reduce expanses of impervious surfaces that can alter local hydrology and degrade water quality. In turn, new street designs can influence the layout of lots and help to increase the volume of open space in new residential developments.

When coupled with narrower, open-section streets, a well-designed street layout can eliminate hundreds of square feet of impervious surface. Depending on the density, location, and type of subdivision, different types of street layouts may easily lend themselves to a cluster arrangement, conserving natural features, maintaining open space, and protecting water quality.

INTRODUCTION

What if you could simultaneously reduce your residential development and infrastructure costs, conserve and protect the environment, increase the marketability of your projects, and improve housing affordability? It may sound too good to be true, but many developers throughout the nation have been able to meet these ambitious goals. How? By incorporating a growing collection of innovative practices and technologies into their existing land development processes and practices.

Low Impact Development (LID) is an approach to land development that uses various land planning and design practices and technologies to simultaneously conserve and protect natural resource systems and reduce infrastructure costs. LID still allows land to be developed, but in a cost-effective manner that helps mitigate potential environmental impacts.

There are numerous design practices and technologies developers can use through the LID approach. For instance, developers can work together with municipal officials and the general public during the initial planning stages of development to identify environmental protection opportunities. Examples of opportunities include saving trees on the site, not building on designated sensitive areas, orienting roads and lots to allow for passive solar orientation of homes, and enhancing the effectiveness of on-site wastewater treatment systems. Such efforts have resulted in rapid home sales, enhanced community marketability, and higher-than-average lot yields.

This publication often refers to “technologies.” For the purposes of the discussion, an LID technology can be structural or nonstructural. Equipment such as a sand filter is an example of a structural technology used to treat wastewater. Nonstructural LID technologies often use natural features or are land use strategies. An example of a nonstructural technology is the disconnection of rain gutters from storm water drains and redirection of rainwater toward rain gardens or grass swales.

To developers, LID can offer both infrastructure savings and a way to respond to increasingly stringent environmental regulations. For municipalities, LID can help contain burgeoning street and storm water management costs. For community residents, LID can encourage local environmental stewardship. And, for the environment, the benefits speak for themselves.

Definition of LID

Low Impact Development (LID) is an approach to land development that uses various land planning and design practices and technologies to simultaneously conserve and protect natural resource systems and reduce infrastructure costs. LID still allows land to be developed, but in a cost-effective manner that helps mitigate potential environmental impacts.

SCOPE

In 1993, the U.S. Department of Housing and Urban Development published *Proposed Model Land Development Standards and Accompanying Model State Enabling Legislation* to support its mission of providing decent, safe, and suitable living environments for all Americans. This important publication focused on the identification and elimination of unnecessary land development practices that add to a home's final cost. Many of the standards also offered ancillary environmental benefits. As an indication of the publication's impact on land development, the volume led many states and municipalities to consider, and in the case of New Jersey directly adopt, some of the standards. Indeed, the publication's recommendations are as applicable today as they were in 1993. Appendix D contains the 1993 publication's Table of Contents. HUD USER (Telephone: 800-245-2691) can provide the entire 1993 publication to anyone interested in obtaining it.

This current effort by HUD's Office of Policy Development and Research is intended to complement and build on the information presented in the 1993 HUD document. It provides users with state-of-the-art information on relevant technologies that can help address both economic and environmental issues related to land development. Specifically, this document is designed to:

- Increase developer and public official awareness of LID opportunities;
- Discuss the alternative technologies available to developers;
- Encourage flexibility in local development codes;
- Continue to promote housing affordability; and
- Reduce land development's environmental impacts.

While LID may benefit all types of development, it is best suited for new, suburban residential development. Moreover, the LID practices and technologies are best integrated into a developer's existing land development process and practices. With some planning, the technologies described in this document can be integrated into today's land development projects. Based on a comprehensive site analysis (see Section 1.5.3), developers can decide which technology or combination of technologies will offer the best cost and environmental benefits taking into account the local ordinances. Developers do not have to incorporate all of the LID technologies noted herein into every development, rather, it is suggested developers carefully select the technologies appropriate to a site's unique regulatory, climatic, and topographic conditions.

1993 HUD Publication

In 1993, the U.S. Department of Housing and Urban Development published *Proposed Model Land Development Standards and Accompanying Model State Enabling Legislation* to support its mission of providing decent, safe, and suitable living environments for all Americans. This important publication focused on the identification and elimination of unnecessary land development practices that add to a home's final cost.

HOW TO USE THIS DOCUMENT

This publication consists of two parts (see Table 1). Part I outlines the objectives of LID and explains how the approach can be easily integrated into a developer's project planning and design process. Part II presents the alternative practices and technologies that can be integrated into the land development process. In accordance with project objectives, site designers should explore the application of either an individual technology or a combination of technologies. For instance, planning for the conservation and protection of water resources on a project site may involve the integration of both storm water and wastewater management technologies. In sum, developers can first learn the objectives of LID (Part I) and then identify the practices and technologies (Part II) that can maximize the project's economic and environmental goals.

Part II of the document contains the following sections: Storm Water Management, Wastewater Treatment, and Circulation and Design, each of which was selected for its potential to offer the greatest LID benefits. Lastly, Appendix A contains a glossary, while Appendix B contains case studies that provide builders with real-world success stories of projects that used LID, Appendix C provides a list of references, and Appendix D provides the 1993 US HUD publication *Proposed Model Land Development Standards and Accompanying Model State Enabling Legislation's* table of contents.

The Practice of Low Impact Development		
Introduction	Part I	Part II
Definition of LID Relationship to 1993 Publication	LID Objectives Project Planning and Site Design	Alternative Technologies <ul style="list-style-type: none"> • Storm Water Management • Wastewater Treatment • Circulation and Design

TABLE 1. OVERVIEW OF DOCUMENT

AUDIENCE

This document is intended primarily for residential building professionals as they work through the initial stages of project planning and design. In addition, municipal planning officials benefit as the document can help them during various stages of the project development process.

Building professionals such as builders/developers, engineers, planners, and landscape architects using the LID approach indicate that successful projects require meticulous planning and design. Consulting this document before initiating the planning process can help building professionals identify and implement a range of LID practices and technologies and thus maximize a project's potential.

Municipal planning officials can also benefit from the use of this document. Reference to the document during the review and permitting stages of development can help officials understand the use of LID practices and technologies. Municipal planning officials are often responsible for drafting and enforcing local development codes and reviewing and approving preliminary site plans. Therefore, in addition to helping to educate municipal officials on the LID approach, the document can help encourage the amendment of existing development codes to facilitate the use of LID practices and technologies.

Section 1.4 discusses the challenges involved in implementing LID. The success of developments such as the Somerset community in Prince George's County, Maryland, and the Kensington Estates community in Pierce County, Washington, proves that developers and public officials can work together to integrate LID practices and technologies into today's projects. These communities have received praise for reducing strains on land, water, air, and soil resources.

**PART I:
PROJECT PLANNING AND DESIGN**

SECTION 1. LOW IMPACT DEVELOPMENT (LID) PRIMER



The LID approach to land development uses various land planning and design practices and technologies to simultaneously conserve and protect natural resource systems and reduce infrastructure costs.

1.1 OVERVIEW

In the mid 1990s, the Prince George's County, Maryland, Department of Environmental Resources outlined an approach for addressing suburban storm water management. That approach, termed Low Impact Development (LID), uses certain technology-based practices to ensure that a site's post-development hydrologic functions mimic those in its pre-development state. These functions include groundwater recharge, infiltration, and frequency and volume of discharges.

For the purposes of this document, we have expanded the concept of LID to include site planning and design considerations as well as wastewater management considerations.

1.2 BENEFITS OF LOW IMPACT DEVELOPMENT

LID reexamines traditional development practices and technologies and focuses on identifying project-specific site solutions that benefit the municipality, the developer, the home buyer, and the environment. Elements of the approach are also known by other names, such as conservation design, environmentally friendly design, resource-efficient design, and better site design. In addition to the fact that LID makes good sense, low impact development techniques can offer many benefits to a variety of stakeholders (see Table 2).

1.3 GOALS OF LOW IMPACT DEVELOPMENT

Many developers are aware that incorporating low impact development into their existing practices helps them systematically balance environmental and cost issues. In particular, residential building professionals using the LID approach seek to do the following:

Preserve Open Space and Minimize Land Disturbances

Successful LID communities recognize the value of open space, mature landscapes, and native vegetation. Open-space tracts incorporated into community designs and planned as components of larger, contiguous areas are highly desirable; in fact, homeowners frequently seek assurances that their community enjoys easy access to undeveloped areas located nearby. Minimizing land disturbance helps dampen the impacts to ecological and biological processes both on and off the site.

Protect Sensitive Natural Features and Natural Processes

Protection of a site's sensitive natural features and natural processes is paramount to planning for LID. Judicious application of information gained in a site analysis can help identify developable and nondevelopable areas of a site and minimize impacts to air, water, soil, and vegetation (see Section 1.5.3).

Identify and Link On- and Off-Site "Green Infrastructure"

Green infrastructure represents the planned and managed network of wilderness, parks, greenways, conservation easements, and working lands with conservation value that support native species, maintain natural ecological processes, and sustain air and water

resources. Site planners should strive to identify on-site opportunities to support and expand regional green infrastructure.

Developers
<ul style="list-style-type: none"> • Reduces land clearing and grading costs • Reduces infrastructure costs (streets, curbs, gutters, sidewalk) • Reduces storm water management costs • Increases lot yields and reduces impact fees • Increases lot and community marketability
Municipalities
<ul style="list-style-type: none"> • Protects regional flora and fauna • Balances growth needs with environmental protection • Reduces municipal infrastructure and utility maintenance costs (streets, curbs, gutters, sidewalks, storm sewers) • Fosters public/private partnerships
Home Buyer
<ul style="list-style-type: none"> • Protects site and regional water quality by reducing sediment, nutrient, and toxic loads to waterbodies • Preserves and protects amenities that can translate into more salable homes and communities • Provides shading for homes and properly orients homes to help decrease monthly utility bills
Environment
<ul style="list-style-type: none"> • Preserves integrity of ecological and biological systems • Protects site and regional water quality by reducing sediment, nutrient, and toxic loads to waterbodies • Reduces impacts to local terrestrial and aquatic plants and animals • Preserves trees and natural vegetation

TABLE 2. BENEFITS TO STAKEHOLDERS

Incorporate Natural Features (Wetlands, Riparian Corridors, Mature Forests) into Site Designs

LID takes advantage of natural resources for both their functional and aesthetic qualities. For instance, when designed correctly, wetlands and pond systems can provide storm water management solutions as well as aesthetic and recreational benefits for the entire community, thus increasing lot and community marketability.

Customize Site Design According to the Site Analysis

Planning for LID communities relies on the performance of a thorough site analysis. Site planners can use the information gathered during the site analysis to create the best balance between development and the conservation of natural resources. By identifying buildable and nonbuildable areas of a site, planners can direct development into areas that will experience the least impacts on air, soil, and water.

Decentralize and Micromanage Storm Water at Its Source

Understanding the difference between pre- and post-development hydrologic patterns is critical to LID. The use of best management practices to reduce the amount of impervious surfaces, disconnect flow paths (i.e., downspouts connected to storm sewers), and treat storm water at its source all help minimize the impacts to local hydrology. Attainment of these goals can lead to the protection of water quality, reduction of impervious surfaces, increased open space, protection of trees, reduced land disturbance, decrease in infrastructure costs, and reduced homeowner energy bills.

Associated Benefits of LID
Protection of Water Quality
Reduction of Impervious Surfaces
Increased Open Space
Protection of Trees
Reduced Land Disturbance
Decrease in Infrastructure Costs
Reduced Homeowner Energy Bills

1.4 CHALLENGES TO USING LOW IMPACT DEVELOPMENT

While the LID approach can result in a myriad of benefits for the developer, the municipality, and the environment, the proposed use of LID is likely to spawn questions during the development process. Two of the most frequent challenges facing developers who contemplate the use of LID center around restrictive local ordinances and local officials' and citizens' opposition to the approach. However, careful project planning, close collaboration with the local municipality, and education programs can reduce the challenges. Appendix B includes several case studies that developers can use to support their decisions to use LID.

Local ordinances guide the design and construction of new development. Often, a community drafted and adopted its ordinances years ago such that the regulations no longer reflect today's development practices, especially those of LID. In many cases, developers wishing to use LID may have to obtain some type of variance or waiver from their local planning agency until local codes are updated to reflect current practice. Unfortunately, variances can create delays in the approval and permitting process, and those delays often translate into more debt service on the loans secured for the original land purchase.

As a pure business decision, it usually does not make sense for a developer to go through the potentially time consuming steps of the variance process. One way to address this issue is to have municipalities reword their zoning ordinances in order to allow LID in residential land development projects. One thing that would help facilitate the ordinance revision process is the development of a nationwide database containing information on ordinances supporting the use of LID. This database would provide the entire development industry, including local planning officials, with a centralized resource that would provide examples of ordinances

Helping Communities Permit the Use of LID
Developers work within the local land development regulations. If a municipality would like developers use the LID approach in future projects, then the zoning ordinances should encourage such a change. However, municipal officials are looking for information on how to best provide flexibility in the local development regulations. Municipal officials have asked for a nationwide database containing information on sample zoning ordinances that support the use of LID. Since such a database does not currently exist, creating and updating an information clearinghouse would address one of the significant challenges in front of people interested in using the LID approach.

that encourage the LID approach.

Ideally, the time to obtain permit approval for an innovative land design should be at least equal to the time needed to develop that same parcel of land under the provisions of existing regulations. Developers incorporating LID practices and technologies into their projects should ask for expedited permitting or pre-development assurances that review and permitting times will not be extended. In fact, public officials that want developers to use LID technologies can tie incentives, such as expedited permitting process times, to developments incorporating those technologies. Until development ordinances are amended to allow innovative practices and technologies by-right, other incentives, such as density bonuses and reduced impact, application, or development fees can also be negotiated between developers and municipal officials to help offset additional costs. .

Local citizens may also show resistance to accepting the proposed use of LID within their communities. Misconceptions and minimal data regarding the safety and long-term viability of LID systems have led to questions concerning the practices' and technologies' efficacy, particularly in terms of flood control and public health and safety. To help homeowners, and sometimes even municipal officials, understand the benefits of LID techniques, developers may find it helpful to prepare brief educational presentations or publications on LID for both the general public and municipal officials. Studies have shown that once residents understand the benefits to local water quality, they are more likely to support and accept alternative technologies. Often, homeowners view practices such as bioretention cells as extra builder landscaping.

1.5 PLANNING FOR LOW IMPACT DEVELOPMENT

Proper team development and collaboration, (see Section 1.5.1), careful coordination with the public reviewing agency (see Section 1.5.2), and the performance of a thorough site analysis (see Section 1.5.3) are essential ingredients for successfully incorporating LID concepts into development plans.

Table 3 highlights some of the ways in which LID differs from conventional development. Developers who have used LID practices and technologies have indicated that one of the keys to a successful project is to invest additional time and money in the initial planning stages of development. While this idea may be unpopular, the expenditures are often recouped in the form of rapid home sales, enhanced community marketability, and higher lot yields.

Due to the iterative and phased nature of construction, both the collaboration and ordinance review/outreach phases should be conducted continuously from project commencement through completion. For example, changes to one aspect of the project (e.g., lot layout) can affect other aspects of the project (e.g., storm water management). During site construction, the site should be continuously monitored for potential impacts to vegetation, soils, or sensitive water features such that appropriate protective measures can be implemented.

	Collaboration	→ Ordinance Review/Outreach	→ Site Review and Analysis
Traditional Practice	<ul style="list-style-type: none"> • Often uses an engineering team and one or two other experts. • Uses experts sequentially, i.e., conducts one phase of development process and then passes project details to the next expert. 	<ul style="list-style-type: none"> • Limits interaction with public officials to permitting meetings. • Does not actively seek out public's input on design options. • Meets existing ordinances. • Uses pre-development meetings to review preliminary site plans. 	<ul style="list-style-type: none"> • Analyzes the land use ordinances to identify regulatory barriers. • Conducts review with the goal of developing one design plan. • Meets the regulatory requirements.
Low Impact Development Practice	<ul style="list-style-type: none"> • Uses experts such as landscape architects, engineers, hydrologists, geologists, and biologists to collaborate, perform site analysis, and identify innovative solutions. • Encourages collaborative effort among all site design professionals to maximize natural resource benefits. 	<ul style="list-style-type: none"> • Proactively seeks public officials' input in pre-development meetings to identify project opportunities. • Works with the community to include its interests in project design. • Conducts resource analysis first to determine what the site offers. Reviews the ordinances to determine potential barriers to proposed designs. Design must meet ordinances or developer obtains a variance. 	<ul style="list-style-type: none"> • Analyzes the land and ordinances to identify resource opportunities and constraints. • Reviews all inputs to create multiple land design options for consideration. • Works together with public officials to gain flexibility in the design phase.

TABLE 3. COMPARISON BETWEEN LOW IMPACT DEVELOPMENT AND TRADITIONAL LAND DEVELOPMENT PROCESSES

1.5.1 COLLABORATION

Historically, engineers have assumed primary responsibility for identifying a site's natural resources and integrating them into project designs. These professionals, however, may or may not have undergone the specialized training necessary to carry out their assigned tasks in the context of the LID approach. Engineers working on LID projects have benefited from the input of a variety of natural resource and land development professionals, including planners, architects, landscape architects, biologists, ecologists, and hydrologists.

Conducting the site planning process with the assistance of the above professionals increases the likelihood that the design process will disclose all opportunities for low

impact development. For instance, a site located in a headwaters area for sensitive wetlands may need the assistance of a hydrologist to identify strategies to protect local water resources. A landscape architect could help orient houses and lots to take advantage of passive solar heating. Section 1.6 discusses the process of incorporating these opportunities into project goals during the project design phase.

Developers' use of these professionals should obviously reflect a project's size and budget. In fact, the expertise offered by the above professionals may be available from several sources other than the professionals themselves. For instance, project engineers can consult the Internet, periodicals, and local governments to gain insights into efficient natural resource use and land planning practices.¹

1.5.2 ORDINANCE REVIEW/OUTREACH

Before commencing work on any site design, developers committed to integrating LID practices and technologies into their designs should meet with local officials to review current development ordinances. Ordinance review meetings between developers and planning staff can help identify ways in which the public and private sectors can work together to build communities that minimize development impacts. Similar to the pre-development meetings that are now required in many municipalities throughout the country, ordinance review meetings should focus on the ways in which LID practices and technologies can further the intent of current ordinances. Developers should not view the meetings as opportunities for local municipalities to exert added regulatory control, but rather as forums in which the two parties can work together to identify mutually beneficial solutions.

Items to Consider During an Ordinance Review/Outreach Meeting
<ul style="list-style-type: none"> • Street Design and Parking Requirements • Lot Layout and Setback Requirements • Storm Water Management and Wastewater Treatment Practices and Technologies • Bonus Densities or Other Development Incentives • Options for Waivers or Variances

TABLE 4. ITEMS TO CONSIDER

Before the ordinance review meetings, developers should familiarize themselves with the relevant local regulations and the specific LID practices and technologies that they wish to implement. For instance, even though current zoning and storm water management regulations may prohibit the LID approach, a developer might be interested in integrating open-section roadways and grassed swales into a development. At the ordinance review meeting, the developer and the municipality might negotiate a compromise that will allow the developer to implement the practice on certain local streets in exchange for setting aside additional stream buffers elsewhere on the site. Developers can then apply for a variance that will likely be looked upon favorably by municipal officials since it was negotiated earlier between the developer and public official. This win-win situation

¹ Additional resources are listed at the end of each section in Part II.

reduces the developer’s street construction costs and storm water management burden and increases municipal protections for riparian systems.

1.5.3 SITE ANALYSIS

Highly attractive and marketable developments begin with a thorough site analysis that takes into consideration a site’s natural features. A site analysis is a process by which a developer or one or more members of the development team inventories a site’s natural features and attributes to identify development opportunities and constraints. Soils, water resources, vegetative patterns, topography, microclimate, solar orientation, viewsheds, and access are just a few of the site attributes that go into a thorough analysis. Many may view the site analysis as a way to identify and plan for potential constraints that can sideline a project or increase development time or costs. However, as environmental awareness continues to increase, developers have realized that identifying and strengthening potential opportunities can be just as important. Table 5 provides some site analysis considerations that relate to Part II.

Storm Water Management
<ul style="list-style-type: none"> • Topography (low points, high points, ridgelines, swales) • Hydrology (natural drainage patterns, surface and groundwater, wetlands, sensitive water resources) • Vegetation (existing vegetation, tree-save areas, aquatic buffers)
Wastewater Management
<ul style="list-style-type: none"> • Soils (porosity, depth to bedrock, groundwater table) • Topography (slopes conducive to drain fields) • Natural Water Features/Sensitive Waterbodies • Aesthetics (siting) • Vegetation (sensitive areas)
Circulation and Design
<ul style="list-style-type: none"> • Hydrology (natural drainage) • Topography (ridgelines/steep slopes) • Natural Features (viewsheds, waterbodies, forested areas) • Soils (hydric)

TABLE 5. SITE ANALYSIS CONSIDERATIONS FOR TECHNOLOGIES DISCUSSED IN PART II

Before even purchasing a piece of property, a developer usually conducts or commissions some type of feasibility study to identify possible physical, legal, or political barriers to developing the site. A feasibility study differs from a site analysis in that it is not usually conducted to assist in site design. In many instances, lending institutions may require an environmental assessment to identify any potential for site contamination that could increase liability for remediation and raise development costs. The data collected for a feasibility study should by no means be considered complete. Many other sources of public and private information are available (see Table 6). Information gathered from different sources should be synthesized into a single, usable map and taken to the site for

verification, especially given that many public maps do not accurately reflect current local site conditions.

However, a site analysis is about more than just preparing a base map and verifying site conditions. A good site analysis can help site designers integrate the built and natural environments into a functioning whole while ensuring identification of the processes, both natural and man-made, that occur on and off site. Armed with an understanding of a site’s various attributes and functions, site designers can create developments that enhance the site’s ecological integrity.

One of the first concepts to understand about the site analysis is that it can rarely be completed during one site visit. If time permits, the process should involve several site visits at different times to observe the effects of seasonal and climatologic changes on the property. For instance, site hydrology may change drastically from the spring to the summer or views may differ radically during the winter months when trees shed their leaves. Designers should also examine on- and off-site connections such as wildlife corridors, riparian areas, or valley systems. The value of these systems should be considered in terms of both their intrinsic value and their connection to their counterparts in the regional environment. Site analysis usually brings together three primary areas of interest: water, vegetation, and soils/topography as discussed below.

Possible Sources of Information for a LID Site Analysis
<ul style="list-style-type: none"> • City/County/State/Federal Maps • National Flood Insurance Program (NFIP) Floodplain Maps • Aerial Photographs • National Wetlands Inventory (NWI) Maps • Topography/Soils (U.S. Geological Survey/Soil Conservation Service / Natural Resources Conservation Service - USGS/SCS/NRCS) • Local Tax/Plat Maps • Seismic Maps • Hazard Maps • Coastal Zone Management Maps

TABLE 6. SOURCES OF INFORMATION

Water

Increasingly, public officials are evidencing concern over water quality and quantity. When properly protected and enhanced, water features can make a project highly marketable. Studies indicate that homebuyers will pay premiums not only for waterfront lots but also for lots with water views or lots in communities with desirable water features such as lakes or streams.

Many different water resources can exist on a given site, and all should be inventoried and their hydrologic relationships understood. It is important to keep in mind that the connectivity of hydrologic systems means that impacts to one resource may affect

another. For instance, sheetflow regime changes may affect a wetlands system, which may in turn affect both groundwater recharge rates and baseflows to streams.

In addition to surface water sources such as streams, rivers, and lakes, other less evident sources of water are equally important and must be identified and protected. Wetlands, seeps, and springs are groundwater-based sources that in most instances fall under the jurisdiction of the federal Clean Water Act. Since they are fed by groundwater, these features may ultimately determine the location of roads, lots, structures, and on-site storm water management or wastewater treatment systems.

Site designers should consider sheetflow characteristics and seasonally inundated areas. Sheetflow is the movement of rainwater across the surface of landscape or, in other words, how the site drains. Flow paths should be identified and natural channels inventoried and protected. Seasonally inundated areas, which are temporarily ponded shallow depressions that exist during rainy seasons, provide habitat for aquatic and migratory species and should be protected.

Vegetation

Trees can be valuable resources on project sites. They can significantly increase the value of individual lots by moderating temperatures within and outside structures, acting as wind buffers, and benefiting water quality.

Vegetated riparian buffers and forested areas have the capacity to reduce storm water volumes, remove pollutants, and slow erosive flows. Current national trends indicate that buyers seek lots with mature vegetation. Builders now realize that the preservation of mature trees and stands of trees can mean more attractive communities. Viable tree areas should be inventoried and protected by a comprehensive tree preservation plan implemented before site clearing and grading. Most municipalities now mandate some form of tree protection and may offer credits for preservation of existing stands. Tree-save areas should be incorporated into both buildable and nonbuildable areas of a site.

Tree-save areas are areas preserved on a development tract to meet tree ordinance requirements and/or to protect healthy vegetation from site development activities.

Soils/Topography

Soils and topographic studies can help determine the placement of streets, lots, buildings, wells, drainfields, and other site amenities. A thorough analysis of all related soils information, including percolation and other geotechnical studies, is an essential component of the site analysis. Given that federal government soil surveys are highly generalized, planners should not rely on them for site-specific soils information. Hydric, or wetland soils, should be delineated by a certified wetlands professional and verified by the local U.S. Army Corps of Engineers field office.

1.6 SITE DESIGN FOR LOW IMPACT DEVELOPMENT

Once the planning phase is complete, the resultant information can be used in the formulation of the final site design. Often, standardized residential templates are overlaid on a site without regard to a site's natural features and environmental sensitivities. These "forced" patterns cause unnecessary impacts to local water, vegetation, and soils and can artificially inflate the infrastructure costs associated with clearing and grading.

Given that land development projects vary as widely as the parcels of land to be developed, it is difficult to prescribe an exact design process for every situation. The three topics discussed below, site area classification, circulation design, and infrastructure and natural resources design, are part of an LID approach that should embrace the various design determinants and variables identified in Figure 1. The list of design determinants and variables identified in the figure is by no means exhaustive. Site designers should identify a complete list of these items based on each site's characteristics.

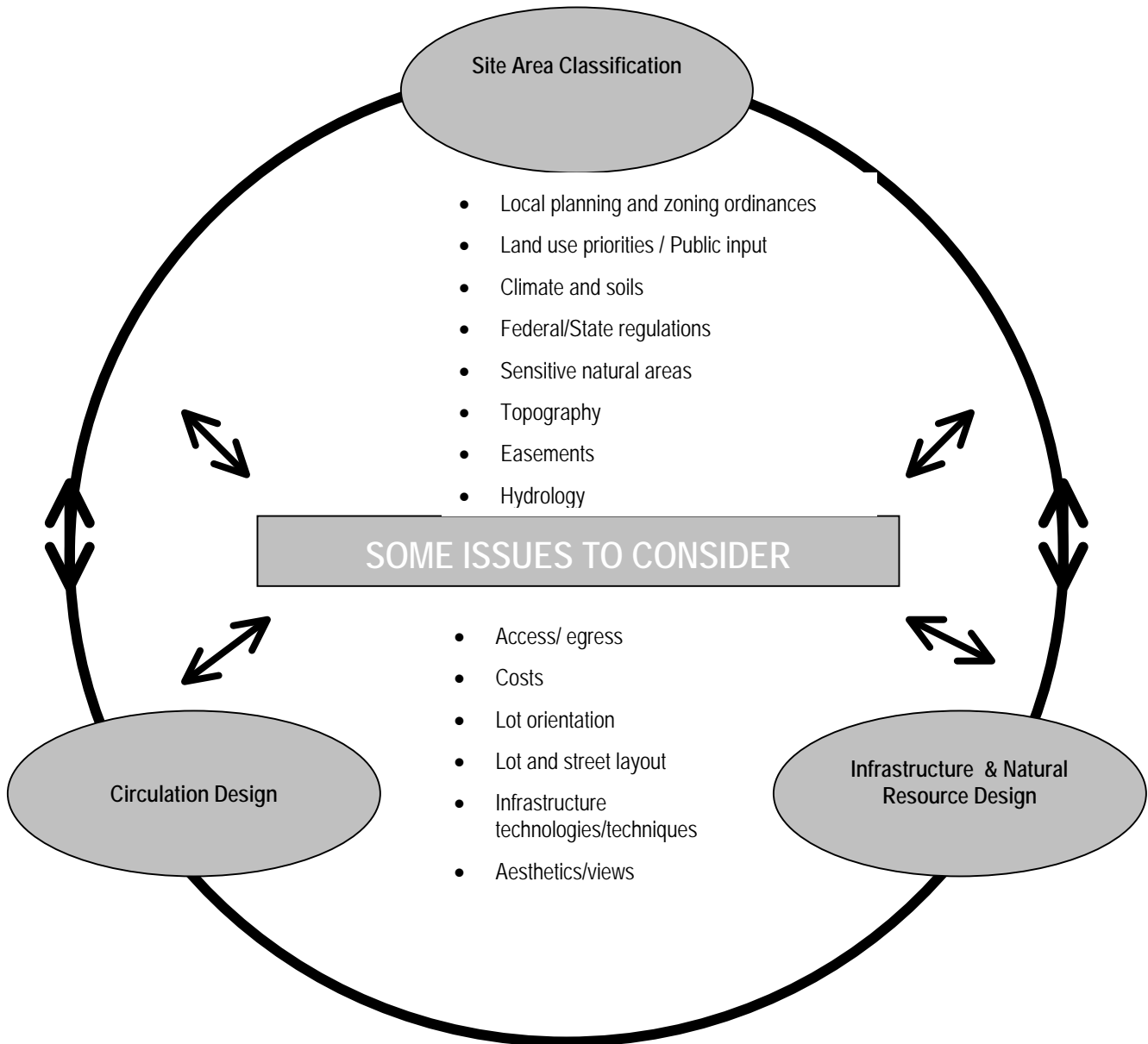

FIGURE 1. LOW IMPACT DEVELOPMENT SITE DESIGN

1.6.1 SITE AREA CLASSIFICATION

Once the site analysis is complete, site designers should analyze and classify areas of the site by suitability of use. During the process of site area classification, it is important to keep in mind that maximizing a site's development potential does not necessarily mean that the entire site needs to be developed. Compact forms of development make it possible to conserve open space and protect habitat and water quality while promoting housing affordability and a sense of community.

Even though open, nonvegetated areas are usually seen as prime development areas, site designers should remain flexible and take into account all natural resource information collected during the site analysis. For instance, a field might serve as a headwaters area for sensitive wetlands or be better developed into recreational fields for a park system.

Buildable Areas

Buildable areas of a site are the areas that are optimal for conversion into finished lots. Buildable areas usually have the fewest limitations in terms of access, regulatory restrictions, sensitive natural features, and zoning concerns. The process of identifying a site's buildable areas may point to the advisability of clustering development into several small areas rather than spreading it throughout one large area. While clustering can protect sensitive site features, it can contribute to infrastructure costs by increasing the excavation and construction costs for streets and utility lines. Yet, narrower streets and rights-of-way and smaller lot sizes mean that less land needs to be developed, permitting the achievement of lower development costs.

Nonbuildable Areas

Nonbuildable areas of a site should remain undeveloped in response to regulatory, natural resource, planning, or other development concerns. These areas can easily be incorporated into either community open space or larger regional systems. During site construction, nonbuildable areas should be protected with silt or tree protection fences, and equipment and materials should not be stored in them. Even though the areas are intended to remain undeveloped, site designers should examine opportunities to use the areas to accommodate the innovative technologies discussed in Part II (see Section 1.5.3 for additional information on the integration of infrastructure and natural resources).

1.6.2 CIRCULATION DESIGN

As discussed in Section 4 - Circulation and Design, a well-designed pedestrian and vehicular circulation system is critical to the success of a development project. The construction of roads is typically one of the largest infrastructure expenses for land development projects. It is estimated that the cost of paving a road averages \$15 per square yard (The Center for Watershed Protection, 1999). The use of efficient road layouts, street types, and pavement treatments can significantly reduce the cost of roadway construction, decrease the quantity of runoff from a site, potentially increase lot yield and open space amounts, and protect natural resources.

After identifying buildable and nonbuildable areas, site designers should lay out an efficient circulation system that provides for access, parking, and circulation. To

minimize the amount of impervious surfaces, plans should maximize lot frontages and minimize pavement widths.

To minimize grading and to protect riparian channels, roadways should be located on topographic high points and should follow the natural contours of the land, within safe grade tolerances. Grade changes and curves in roadways can add visual interest to streets and communities and to help slow traffic. For additional road design standards, refer to AASHTO's *Green Book* (AASHTO, 1994).

1.6.3 INFRASTRUCTURE AND NATURAL RESOURCES DESIGN

The efficient blending of infrastructure and natural resources on a development site requires a thorough understanding of the natural processes that characterize the site and the infrastructure practices and technologies proposed as part of the land development process. Use of many of the practices and technologies discussed in Part II may allow for an entirely different set of site planning and design considerations. For instance, alternative wastewater treatment systems that use smaller drainfields may permit smaller lot sizes, which in turn can affect lot, road, and open-space layouts. All of the alternative practices and technologies discussed in this publication, whether related to storm water, wastewater, or circulation, affect water, soils, and vegetation. Site designers should use the best combination of systems based on individualized natural resource objectives for a given site.

PART II: PROJECT TOOLS/REFERENCES

SECTION 2: STORM WATER MANAGEMENT

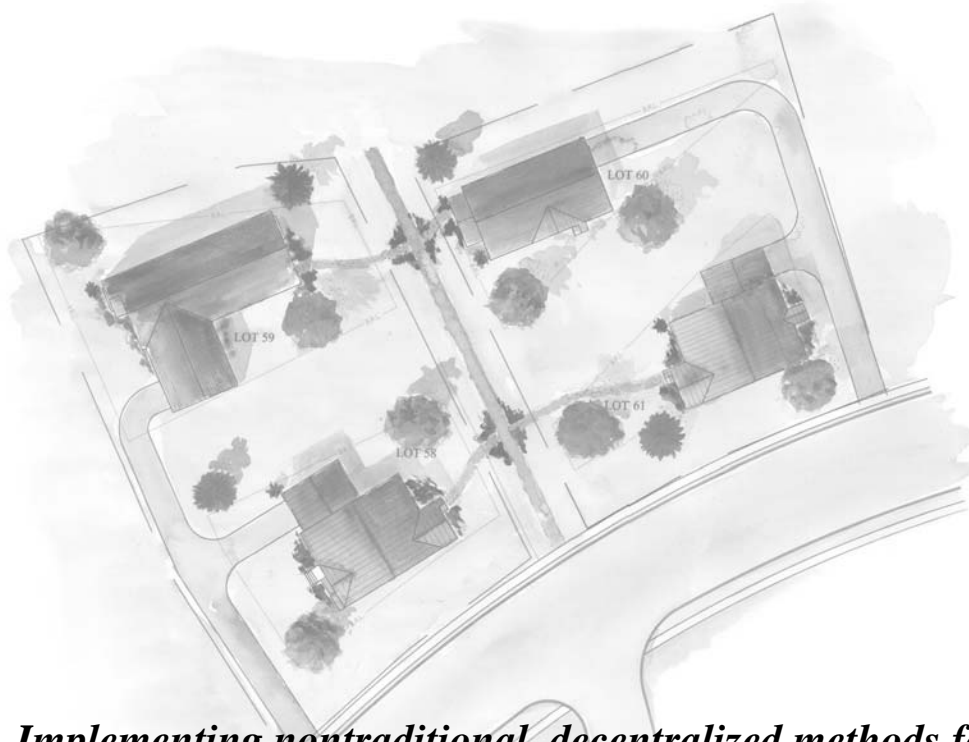

Implementing nontraditional, decentralized methods for handling storm water can significantly reduce site development costs, regional expenditures for storm water and planning, construction, and maintenance outlays while protecting the environment.

2.1 INTRODUCTION

Planning for storm water management in the initial stages of land development can yield significant cost and environmental benefits for developers, municipalities, and residents. Traditionally approached during site development as an obligation to satisfy state and federal regulatory requirements, storm water management has increasingly come under reexamination in light of its potential to function as a project opportunity and site design element. When correctly planned for and accommodated, storm water management systems can simultaneously satisfy regulatory requirements, act as site design elements, protect the environment, and reduce infrastructure costs—all the attributes of low-impact development.

The development of land, whenever and wherever it occurs, affects soils, vegetation, and water. After land is developed, rainwater that would have infiltrated into the ground, been absorbed by plant roots and transpired, or evaporated into the air instead becomes surface runoff. Runoff often picks up urban pollutants such as grease, oil, nutrients, metals, and debris and deposits them into local waterbodies. In addition to water quality impacts, post-development storm water runoff has other impacts, including changes to the peak flow characteristics of streams, degradation of habitat and aquatic species, and fluctuations in local groundwater tables.

Definition of LID

Low Impact Development (LID) is an approach to land development that uses various land planning and design practices and technologies to simultaneously conserve and protect natural resource systems and reduce infrastructure costs. LID still allows land to be developed, but in a cost-effective manner that helps mitigate potential environmental impacts.

Stricter federal water quality requirements under the Clean Water Act have caused both municipalities and developers to seek out more environmentally efficient, cost-effective storm water management alternatives that are compatible with hydrologic and watershed objectives. At the same time, traditional methods for addressing storm water management have brought to the fore other considerations such as cost and maintenance issues, liability issues, and the need for education and outreach programs for local officials and residents.

History of Low Impact Development

Initially developed and implemented by Prince George's County, Maryland, in the early 1990s as an innovative way to handle storm water runoff, LID techniques have rapidly spread across the country. The overall goal of LID storm water treatment is to mimic pre-development hydrologic conditions through the use of a variety of structural and nonstructural practices that detain, retain, percolate, and evaporate storm water. This publication is not intended as a comprehensive guide to LID storm water treatment strategies but merely aims at providing an overview of alternative storm water

Prince George's County, Maryland has pioneered several new tools and practices in LID. The Prince George's County Maryland Department of Environmental Resources Programs and Planning Division (PGDER) created two publications: 1) *Low-Impact Development Design Strategies An Integrated Design Approach* (EPA 841-B-00-003), and 2) *Low-Impact Development Hydrologic Analysis* (EPA 841-B-00-002). These publications describe how LID can achieve storm water control through the creation of a hydrologically functional landscape that mimics the natural hydrologic regime.

management practices and technologies. For a comprehensive look at the LID process, readers should consult the Prince George's County, Maryland, Department of Environmental Resources for copies of its LID publications (Telephone: 301-883-5810).

Cost Benefits

Low impact development storm water management systems can reduce development costs through the reduction or elimination of conventional storm water conveyance and collection systems. LID systems can reduce the need for paving, curb and gutter, piping, inlet structures, and storm water ponds by treating water at its source instead of at the end of the pipe. However, developers are not the only parties to benefit from the use of LID storm water management techniques. Although more data is needed on the maintenance of LID technologies, recent history has indicated that municipalities may also benefit in the long term through reduced maintenance costs.

Environmental Benefits

As storm water drains from urban areas, it picks up nutrients and pollutants such as nitrogen, phosphorus, oil, grease, heavy metals, and trash. These pollutants impair water quality and degrade the riparian systems that many plant and animal species depend on for survival. LID practices remove pollutants from storm water naturally and restore a site's pre-development hydrology. The alternative practices discussed later can recharge local groundwater tables, reduce domestic water use for lawns and vegetation, and provide habitat for a variety of species.

Storm Water Management Techniques

This section briefly discusses the different conventional and alternative storm water management techniques available to site designers, briefly highlighting the

LID Practices can Reduce Development Costs by:

- Reducing the use of roadways, curbs and gutters, and sidewalks
- Decreasing the use of traditional storm sewer appurtenances
- Eliminating the use of or downsizing storm water ponds

environmental and economic benefits that each can offer. It is important to keep in mind that regional differences in land characteristics, climatologic conditions, soils, and local ordinances will dictate the availability, type, and effectiveness of options for a given site. Regardless of the practices and technologies ultimately chosen, developers should ensure that they are consistent with the goals of regional storm water management plans. Table 7 lists objectives for alternative storm water management techniques.

Finally, designers should remember that an integrated site storm water management system can use several combinations of conventional and alternative techniques to meet site environmental and watershed objectives. Given that each development site has its own characteristics and constraints, the value of a thorough site analysis and conceptual design phase should not be underestimated. While the complete decentralization of storm water operations is the

Decentralizing Storm Water Management Involves:

- Reducing storm water quantities
- Disconnecting hydrologic elements, such as downspouts and storm drains
- Treating storm water at its source by using alternative techniques

most desirable option for cost savings and environmental benefits, designers may still wish to rely on conventional systems such as wetlands or ponds to promote aesthetic or recreational opportunities.

Objective 1 Reduce the amount of impervious surfaces on the development site.
Objective 2 Manage storm water at the source instead of at centralized collection points.
Objective 3: Use "chains" of natural treatment systems to reduce storm water quantities and pollutant loadings.

TABLE 7. STORM WATER MANAGEMENT OBJECTIVES

2.2 CONVENTIONAL APPROACHES TO STORM WATER MANAGEMENT

Conventional storm water management systems rely on collection and conveyance systems to remove water safely from developed areas and to protect life, property, and health. The systems are engineered and designed according to estimates of post-development storm water flows and volumes from pervious and impervious areas.

Conveyance Systems

Conveyance systems comprise curbs and gutters, inlet and outlet structures, and buried concrete (or other) piping systems that move water from source areas to centralized control areas. Costs for installing a conventional drainage system extend to material, labor, planning, and design costs. Research has indicated that the cost of a conventional conveyance system typically ranges between \$40 and \$50 per linear foot (MNCBIA, 2001). Assuming \$45 per linear foot as an average, the elimination of one mile of curb and gutter can decrease infrastructure and storm conveyance costs by approximately \$230,000.

Collection Systems

Collection systems consist of wet and dry ponds that retain and detain storm flows until they can be safely discharged into local receiving waters. While these systems have functioned well, other strategies for managing storm water that use ecological approaches are gaining popularity. Moreover, traditional ponds are increasingly seen as expensive to design, construct, and maintain. In one residential community in Prince George's County, Maryland, one developer (and, ultimately, residents) saved nearly \$300,000 when the use of individual-lot bioretention practices alleviated the need for a pond. Table 8 provides a summary of some of the current pond types used in residential developments.

It is estimated that storm water ponds in new, suburban developments consume approximately 10 percent of a project's developed land area (England et al, 2000). The elimination of ponds, however, can permit the preservation of additional land as permanent open space or allow for the platting of additional lots. In the example from Prince George's County, the developer was able to recover six lots that would have been lost to the area required for the storm water pond. Beyond the environmental benefits,

studies have indicated that residents are willing to pay premiums for the enjoyment of living next to permanent water bodies, even storm water ponds. At one condominium community in Virginia, the developer was able to receive premiums of up to \$10,000 for waterfront lots (Friends of the Rappahannock, 2000).

Type of Pond	Cost	Advantages	Disadvantages
Dry Retention	Approximately \$25,000 per acre of pond. Maintenance costs \$100 to \$500 per mowed acre.	High pollutant removal efficiencies. Groundwater recharge.	Proper design and construction critical to success. Periodic maintenance costs can be high.
Wet Detention	Approximately \$90,000 per acre of pond. Maintenance costs variable.	Proper design can increase community and property values.	Large land areas needed to accommodate pond. Nitrogen and phosphorus removal capacities limited.
Wet Detention with Filtration	\$100,000 per acre of pond. Maintenance costs variable.	Underdrain pipes with sand filters offer good removal of suspended solids and attached pollutants.	Significant maintenance required. Poor nitrogen and phosphorus removal.

Source: England et al, 2000.

TABLE 8. TYPES OF PONDS CURRENTLY USED IN RESIDENTIAL DEVELOPMENTS

2.3 ALTERNATIVES TO CONVENTIONAL SYSTEMS

Hydrologic alternatives to conventional storm water management systems can result in economic and environmental savings. Instead of piping the water to a central location, these alternatives try to treat the water at its source by infiltrating it into the ground. Some of the alternatives discussed include infiltration systems, filtering systems, alternate conveyance systems, and a few non-structural practices. Often used in support of site design principles that advocate the reduction of impervious surfaces, alternatives aim to mimic natural hydrologic cycles characteristic of forests and woodlands. In fact, hydrologic alternatives help decentralize storm water treatment thereby eliminating the need for expensive conveyance and collection systems such as pipes and ponds (see Table 9).

Hydrologic alternatives to conventional storm water management treat storm water at its source with small, cost-effective cells that use a combination of engineered soils and vegetation to evaporate, transpire, and percolate the storm water. Though significantly less costly to design, install, and maintain than conventional systems, the alternatives are also effective in filtering urban pollutants, recharging groundwater, and maintaining pre-development flows.

Description	Storm water Management Pond/Curb and Gutter Design	Bioretention System
Engineering Redesign	\$0	\$110,000
Land Reclamation (6 lots x \$40,000 net)	\$0	(\$240,000)
Total Costs	\$2,457,843	\$1,541,461
Total Costs--Land Reclamation <i>plus</i> Redesign Costs	\$2,457,843	\$1,671,461
Total Cost Savings = \$916,382		
Cost Savings per Lot = \$4,604		

Source: Derek Winogradoff, 2003.

TABLE 9. COST COMPARISON: CLOSED (CONVENTIONAL) SYSTEM VERSUS BIORETENTION

2.3.1 INFILTRATION SYSTEMS

Infiltration systems encourage the downward movement of water into the underlying soil to reduce the total quantity of overland runoff and pollutants from impervious surfaces. The systems discussed include trenches, drainfields, drywells, bioretention systems, and level spreaders. In comparison with conventional conveyance systems, infiltration systems are inexpensive to design and construct. Their use can reduce the amount and size of storm piping, inlet and outlet structures, and pond systems. However, as is the case with any LID technology, infiltration systems must be carefully engineered to the site's conditions. Table 10 provides a partial list of pollutant removal effectiveness. It is important to keep in mind that these systems are designed primarily for water infiltration and not necessarily for pollutant removal. For vegetated swales and filter/buffer strips there are situations where those systems are not always effective in removing pollutants, and can in fact increase the levels of phosphorus. In fact, a study conducted for the National Association of Home Builders (NAHB) indicates that those system's pollutant removal efficiencies are highly variable (NAHB, 2002b). Thus, building professionals should look at the site's climatic, soil, and other conditions to determine if a certain technology is right for the application.

"First flush" pollutants are higher-concentration pollutant loadings that initially run off impervious areas. As the duration of the rainfall event increases, pollutant loadings usually decrease as compared to the "first flush" levels.

Infiltration Trenches

Infiltration trenches are excavated trenches that are backfilled with an aggregate material to permit the filtration and percolation of water into subsoils. Storm water from impervious areas, including rooftops, parking areas, and driveways, is routed into the trenches for treatment (see Figure 2). Infiltration trenches are usually most effective at treating "first-flush" pollutant loadings in storm water and are extremely effective in recharging groundwater tables that contribute to stream baseflows. It is estimated that the trenches can remove between 80 and 100 percent of total suspended solids, zinc, and lead

from storm water as well as between 40 and 60 percent of total phosphorus and nitrogen. (Prince George’s County, 2001). In areas with high concentrations of pollutants such as sediment, oil, grease, or grit, pretreatment mechanisms such as grassed filter strips should be installed upstream of the system to filter such pollutants before they enter the trench. This linked system concept is considered a “treatment train” approach to storm water management.

System	Total Suspended Solids (TSS)	Total Phosphorus (P)	Total Nitrogen (N)	Zinc	Lead
Bioretention	-	81	43	99	99
Dry Well	80–100	40–60	40–60	80–100	80–100
Infiltration Trench	80–100	40–60	40–60	80–100	80–100
Filter/Buffer Strip	20–100	0–60	0–60	20–200	20–200
Vegetated Swale	30-65	10–25	0–15	20–50	20–50
Infiltration Swale	90	65	50	80–90	80–90
Wet Swale	80	20	40	40–70	40-70
Rain Barrel	NA	NA	NA	NA	NA
Cistern	NA	NA	NA	NA	NA

Source: Prince George’s County Bioretention Manual, 2001.

TABLE 10. REPORTED POLLUTANT REMOVAL EFFICIENCY OF BEST MANAGEMENT PRACTICE (BMP)

Infiltration Drainfields

An infiltration drainfield is generally the same as an infiltration trench except that it functions in a manner similar to a drainfield for a septic system. It consists of a pretreatment structure, a perforated manifold-type arrangement of drain lines, and a permeable drainfield. The drainfield itself consists of layers of topsoil, aggregate stone, sand, and filter fabric. An observation well is usually located in one corner of the system to permit the monitoring of flows. Infiltration drainfields are extremely effective in maintaining hydrologic functions such as infiltration and groundwater recharge and in improving water and stream quality by filtering pollutants and attenuating runoff volumes.

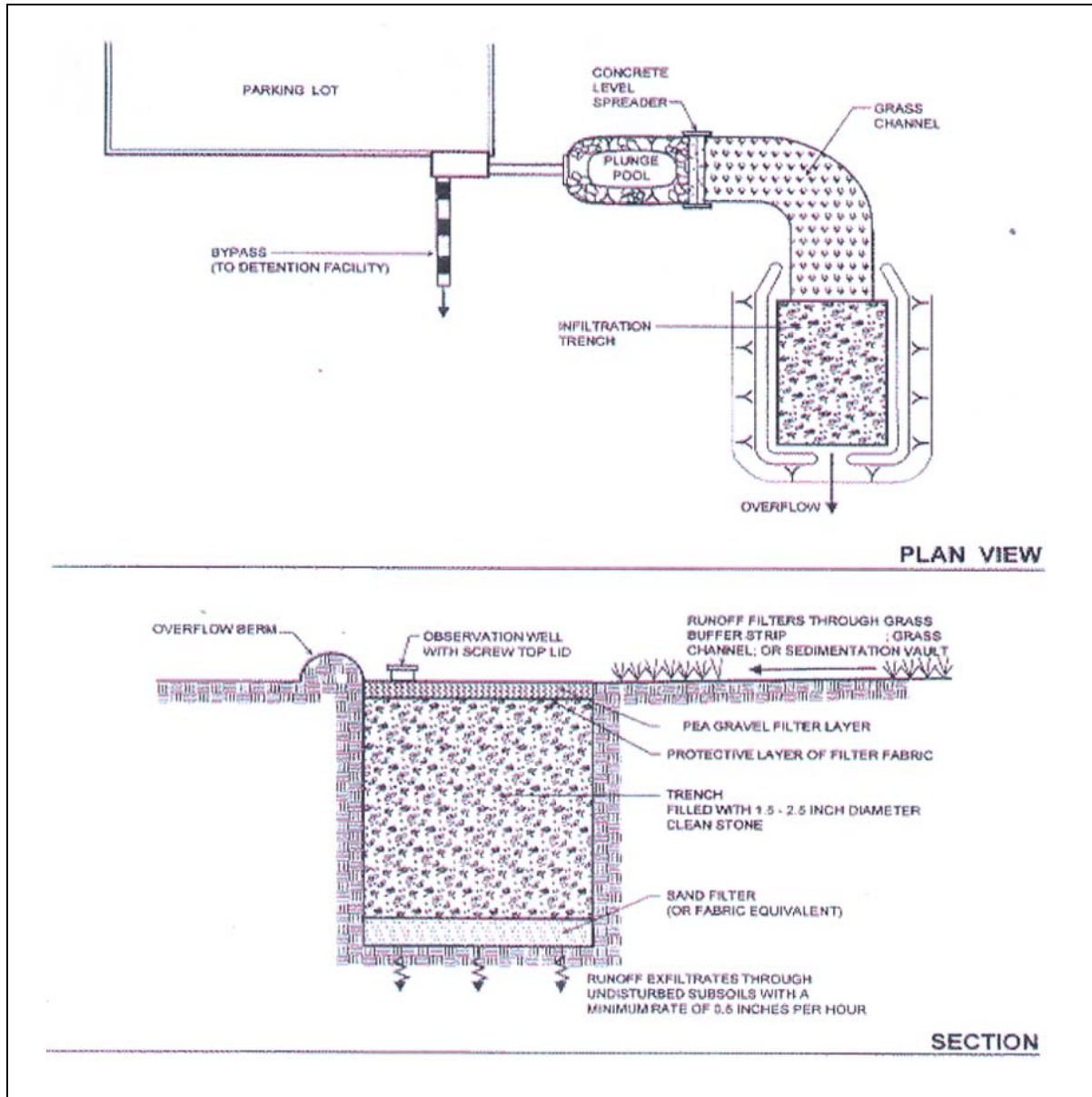

FIGURE 2. INFILTRATION TRENCH

Dry Wells

In residential communities, rooftops account for a significant source of runoff from impervious surfaces. Dry wells, sometimes referred to as “French drains,” are usually sited near downspouts to manage rooftop runoff by infiltrating it into the ground (see Figure 3). Dry wells are excavated pits filled with aggregate stone to hold water until it can infiltrate into the ground. Similar to infiltration trenches, dry wells should be designed with emergency overflow structures that drain to public storm water conveyances to accommodate runoff from major storms. The drainage pathways should be well maintained and stabilized to prevent erosion.

Dry wells are extremely effective in removing sediment, zinc, and lead from storm water and mildly effective in reducing quantities of nitrogen and phosphorus. During construction, developers should take care to avoid excessive compaction of soils around the trenches and the accumulation of silt around the drainfield. Depending on the type of pollutants filtered, drainfields need to be maintained regularly for optimum performance.

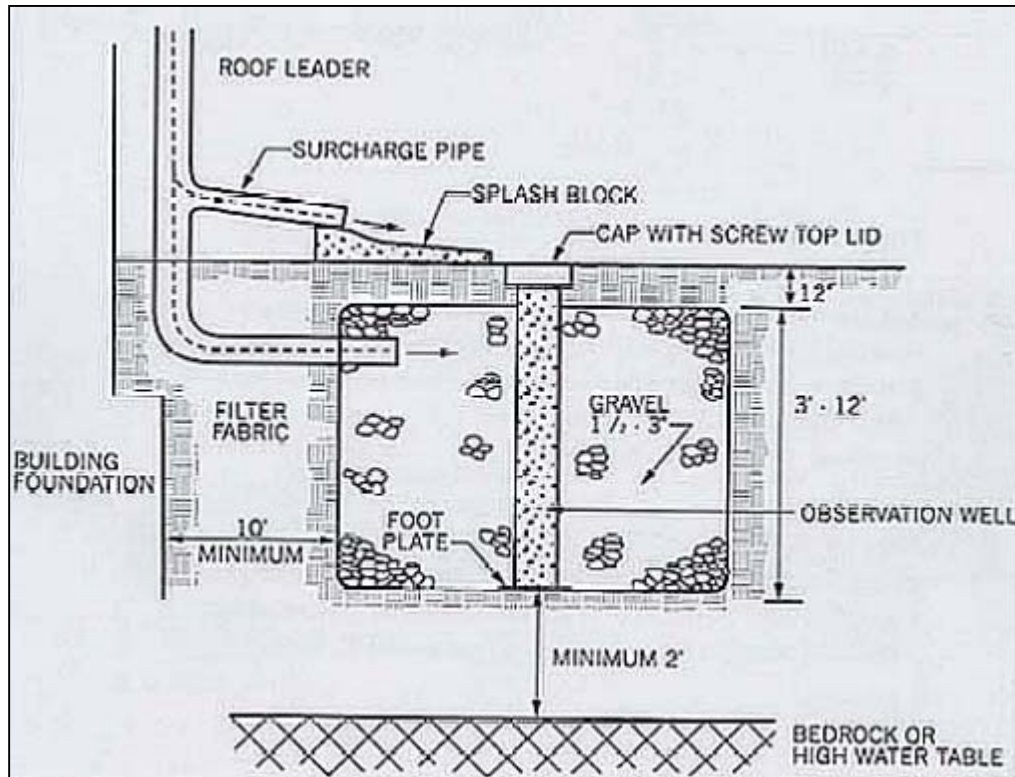

FIGURE 3. DRY WELL

Bioretention

Bioretention is possibly one of the most recognized alternative storm water management practices. Used in residential, commercial, and certain industrial settings, bioretention has the potential to offer developers significant cost savings and environmental benefits over conventional storm water management systems. Bioretention areas are shallow, topographic depressions filled with engineered soils and vegetation that retain, treat, and infiltrate water. Figure 4 depicts a typical bioretention area.

Bioretention systems are designed for the temporary storage of rainwater. They successfully remove pollutants through increased contact time with soils and plant materials. As compared with conventional storm water management systems, bioretention areas more closely mimic the natural hydrologic cycle, allowing soils and plants to filter pollutants from storm water and permitting the processes of infiltration, evaporation, and transpiration to occur. The systems can also create wildlife habitat, minimize erosion, and recharge local groundwater supplies.

In parking lots, storm water should be conveyed directly to the bioretention area through a system of grassed swales. For residential applications, treatment areas are generally located some distance away from houses to increase flow paths and treat runoff from rooftops and driveways. In either case, bioretention systems route storm water to bioretention areas that are designed to accumulate water to depths not exceeding six to 12 inches. In the event that storm water volumes exceed treatment capacities, bioretention areas are usually equipped with overflow drop inlets routed to municipal storm water systems. In certain industrial and commercial areas, pollutant loadings may be too concentrated for the successful use of bioretention areas. In such areas, termed “hotspots,” the use of structural practices to infiltrate storm water may be deleterious to groundwater supplies. In these instances, designers are advised to use alternative practices, such as exfiltration trenches, to convey filtered water into a conventional storm water management system for proper treatment.

On average, bioretention costs approximately \$3 to \$4 per square foot of size, depending on the quantity of water to be treated and excavation costs. Plant materials are approximately \$6.40 per cubic foot of storm water treated.

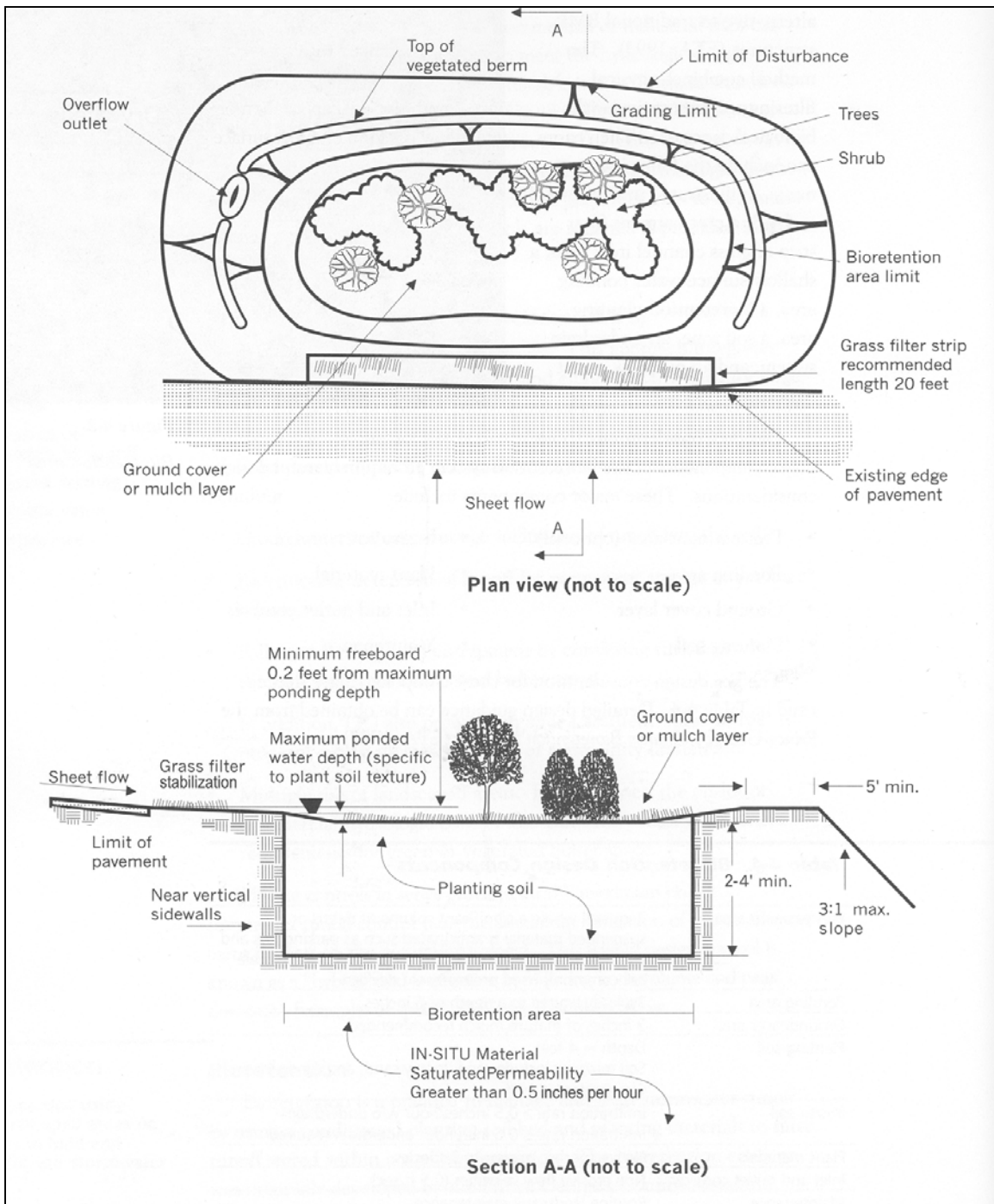

Source: Prince George's County Bioretention Manual, 2001.

FIGURE 4. TYPICAL BIORETENTION AREA

Level Spreaders

Level spreaders are mechanisms that convert concentrated runoff into sheetflow and slow the erosive velocities of storm water. Constructed by excavating a wide, shallow trench and filling it with crushed stone, a level spreader must be built with its lower edge

completely flat to ensure the even disbursement of water. Level spreaders are most effective in helping to convey sheetflow to bioretention areas. While not typically viewed as treatment mechanisms, level spreaders can help increase detention storage and time of concentrations and thus assist with pollutant and sediment removal functions. They should be used as part of an integrated, decentralized storm water management system.

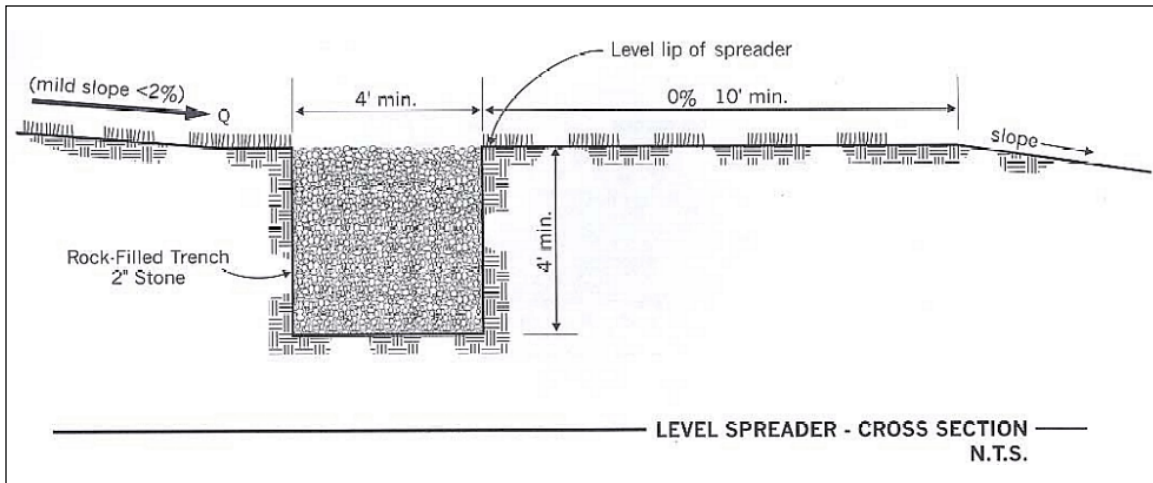

FIGURE 5. LEVEL SPREADER

2.3.2 FILTERING SYSTEMS

Filtering systems use soils and vegetation to remove pollutants from storm water. They function mainly as pre-treatment devices to remove sediment before water enters infiltration devices such as bioretention areas.

Filter Strips

Filter strips are low-grade vegetated areas that permit sediment deposition during sheetflow (see Figure 6). Usually used as one component of a storm water management system, filter strips are considered pre-treatment devices, meaning that water is routed through them before entering systems such as bioretention areas. For the systems to be fully effective, slopes should be minimal (0 to 2 percent), with channelized flows eliminated. Pollutant removal efficiency depends largely on the quantity of water treated, flow path and length, type of vegetation, and the soil infiltration rate. Depending on the amount and type of vegetation planted and the need for replacement or amendment of soils, filter strips can be inexpensive to construct and maintain.

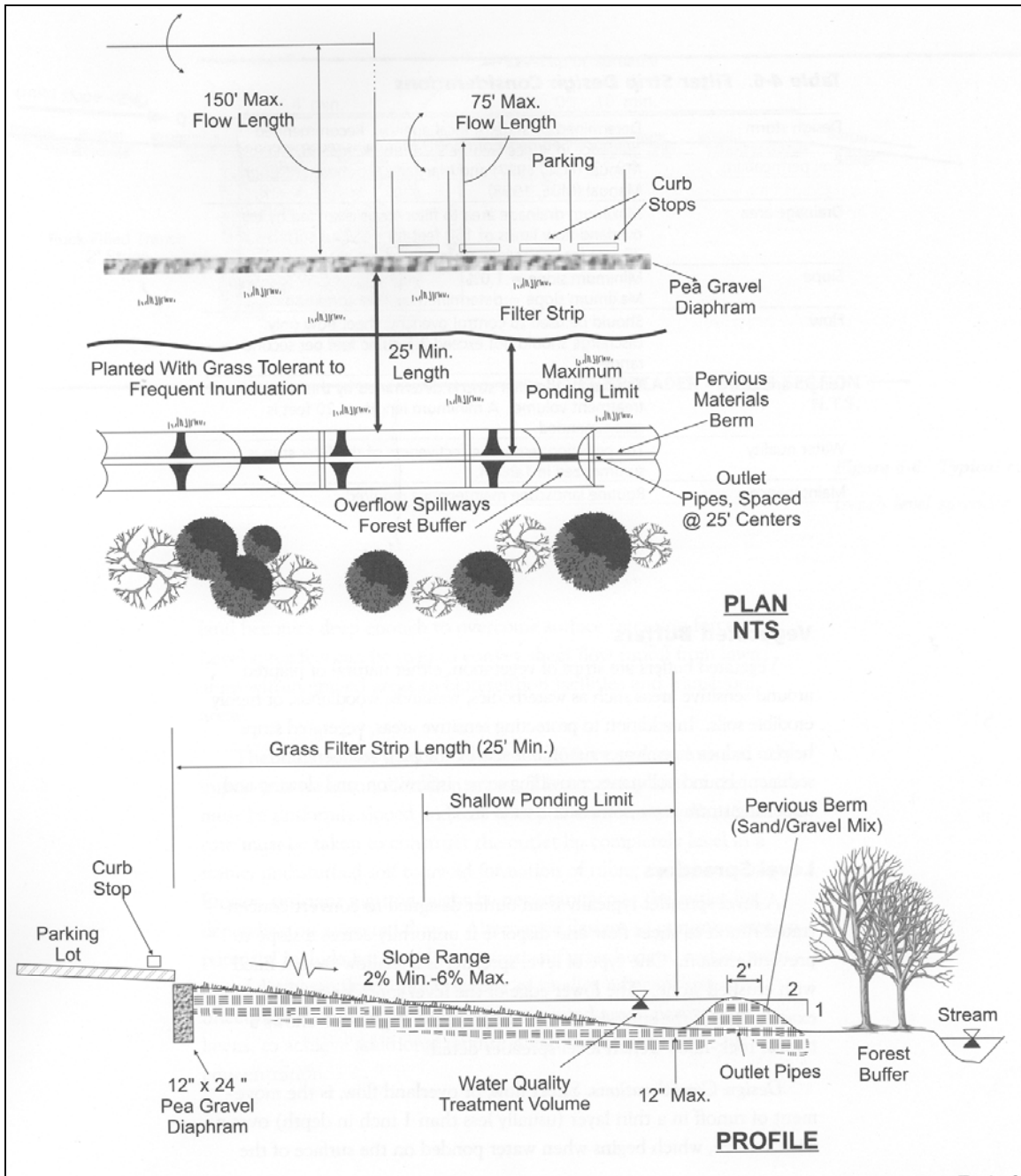

Source: Prince George's County Bioretention Manual, 2001.

FIGURE 6. TYPICAL GRASS FILTER STRIP

Exfiltration Trench/Dry Swale

Exfiltration trenches function in a manner similar to infiltration trenches except for an underdrain system built into the bottom of the trench (see Figure 7). After water has percolated through the soil media and pollutants have been removed, the water enters perforated drain tile and is conveyed to a local storm water drain system.

Exfiltration trenches are low-cost, low-maintenance systems that are highly effective in removing pollutants, especially sediment, from storm water. The perforated underdrain in the system protects groundwater supplies from contamination in areas with high pollutant loadings. These areas, usually termed “storm water hotspots,” are usually located in industrial or commercial areas dominated by vehicular traffic.

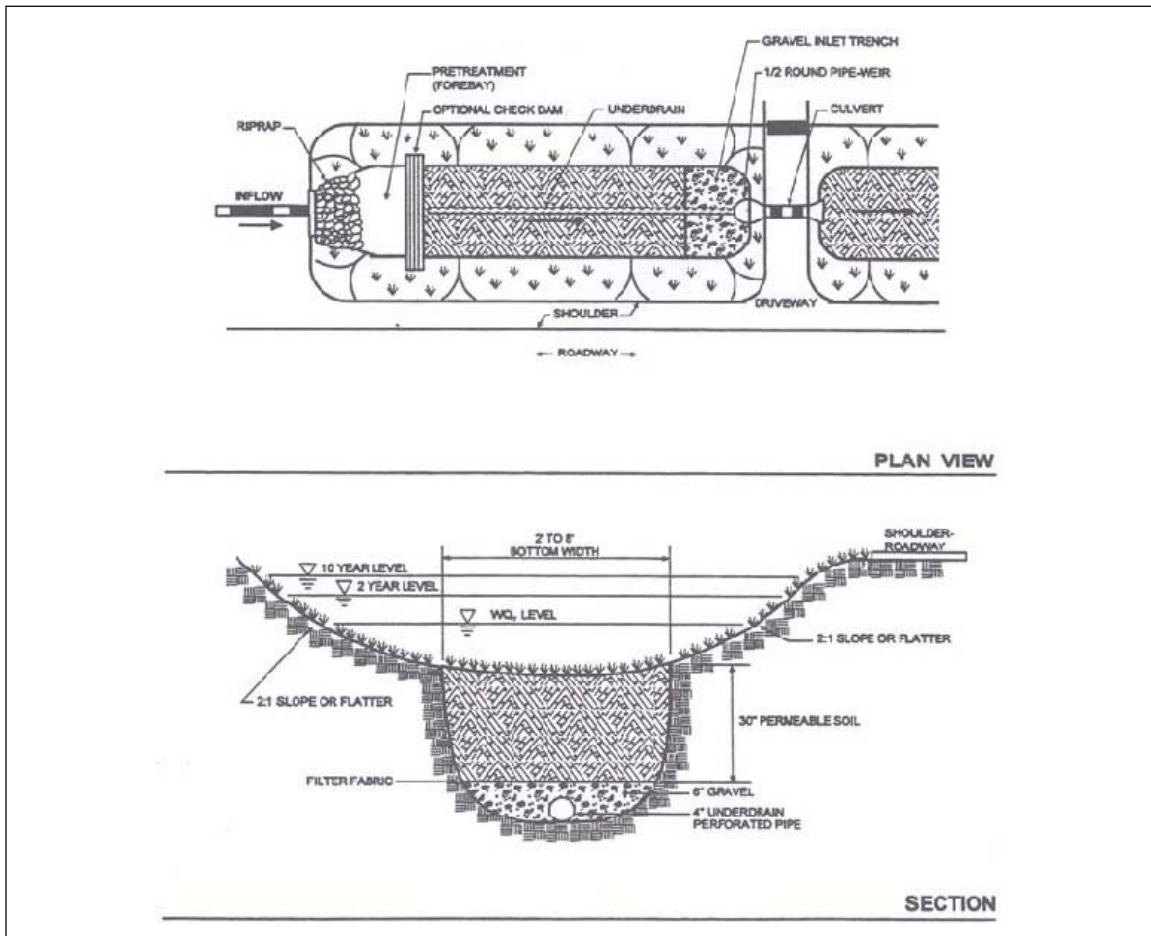

FIGURE 7. EXFILTRATION TRENCH/DRY SWALES

Wetlands

Constructed wetlands systems use soils, vegetation, and hydrology to remove pollutants from storm water. The systems are effective in attenuating flood flows, reducing pollutant loadings, and providing wildlife habitat (see Figure 8). From a community design standpoint, wetlands systems can create open space, offer improved aesthetics over traditional treatment systems, and provide recreational and educational opportunities.

Most natural and artificial wetlands systems are regulated by the Clean Water Act and fall under the jurisdictional authority of the U.S. Army Corps of Engineers (Corps). A recent U.S. Supreme Court decision concerning isolated wetlands has limited the jurisdiction of the Corps to navigable waters, their tributaries, and wetlands adjacent to these navigable waters and their tributaries.

Similar to their natural counterparts, constructed wetlands types can vary from seasonally inundated to year-round, open-water systems. To optimize pollutant removal capacities, design engineers usually aim to maximize flow paths through wetlands systems to prolong exposure to soils and vegetation, thereby facilitating nutrient and pollutant uptake, retention, and settling. Given the delicate hydrologic balance of wetlands systems, unmanaged storm water should never be discharged into jurisdictional wetlands, or wetlands under the direct control of the Corps. Therefore, constructed wetlands should be designed with water quality and quantity pre-treatment mechanisms, such as sediment forebays or gabion walls, which attenuate storm flows and protect sensitive wetlands vegetation.

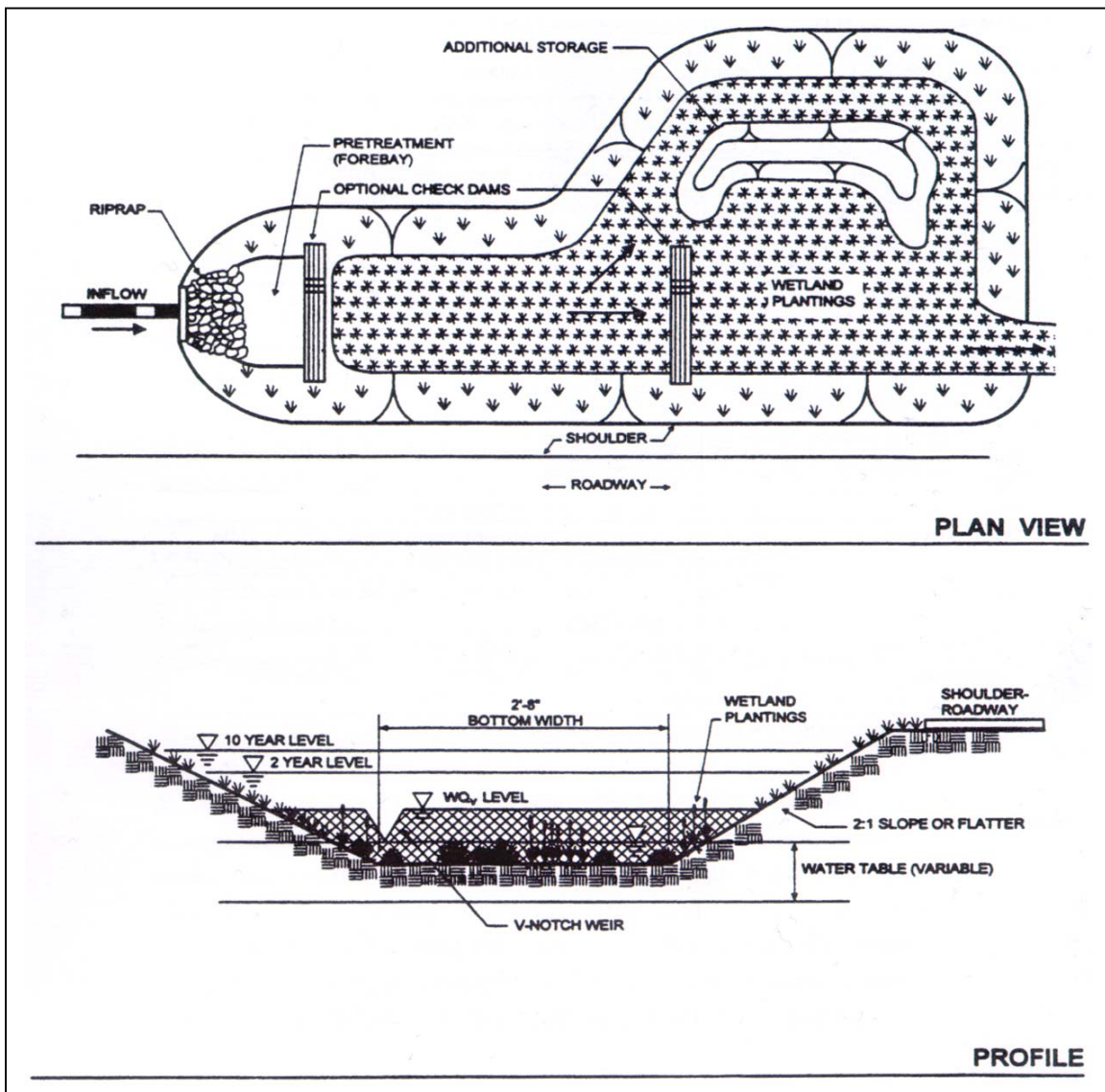

FIGURE 8. STORM WATER WETLANDS

As compared with other alternative systems, construction costs for wetlands systems may be high. The cost of a constructed storm water wetlands can exceed \$300,000 per acre (JSPPOH, 2001), although shallow groundwater levels, shallow depth to bedrock, and

sloping topography can drive up construction costs further. In instances where the depth to groundwater is shallow, a clay liner should be used to prevent contamination of local aquifers. The quality and quantity of imported soils and plant material are also a factor when considering the total cost of built systems. However, while construction costs may be higher for constructed wetlands than for other BMP systems, operation and maintenance costs may be relatively low.

2.3.3 CONVEYANCE SYSTEMS

Alternate conveyance systems, such as vegetated channels and grassed swales, carry water to areas for treatment. Unlike conventional conveyance systems, such as curbs and gutters, these systems slow the erosive velocity of storm water, increase time of concentrating, and filter pollutants such as sediment.

Vegetated Channels/Grassed Swales

Vegetated channel systems and grassed swales are low-cost alternatives for conveying water away from streets, downspouts, and structures. They are low-cost alternatives to conventional conveyance systems, such as curbs or concrete channels. These alternatives reduce storm water velocities and allow sediment and pollutants contained within storm water to be filtered.

Curb and gutter can cost upwards of \$12.50 per linear foot.
Source: Friends of the Rappahannock Study, 2000.

In residential settings, swales are an effective way to convey water to bioretention areas sited a short distance away from structures and foundations. When used in conjunction with bioretention areas, swales function as pre-treatment mechanisms that filter sediments from storm water. For health, safety, and maintenance reasons, minimum longitudinal slopes on swales should be 1 percent to avoid stagnation of water and to ensure proper drainage.

Wet swale systems are variants of dry swales and function similarly to a wetlands system. Slightly more expensive to construct than a vegetated channel or dry swale, wet swales are designed with a permanent pool structure and planted with wetlands vegetation for pollutant treatment. Due to health and safety concerns over potential mosquito breeding, wet swales have limited applicability in residential or commercial settings.

2.3.4 OTHER SYSTEMS

Rain Barrels

Rain barrels are low-cost retention devices placed below roof downspouts to collect water during storms (see Figure 9). Although rain barrels offer no primary pollutant removal benefits during collection times, they act as quantity controls and can help reduce the cumulative effects of storm water on downstream systems. As an example, one 42-gallon rain barrel can provide storage for 0.5 inch of runoff from a rooftop measuring 133 square feet (Prince George's County, 2001).

One inch of rain on a 1,000-square-foot roof yields approximately 623 gallons of water.

During dry periods, water from the barrels can be used to irrigate lawns and vegetation. Rain barrels should be equipped with some type of overflow device that routes overflow to a bioretention area for treatment during major storms. Rain barrels can be purchased online from a variety of municipal natural resources departments and environmental organizations. They are available in a variety of colors and sizes to match architectural styles.

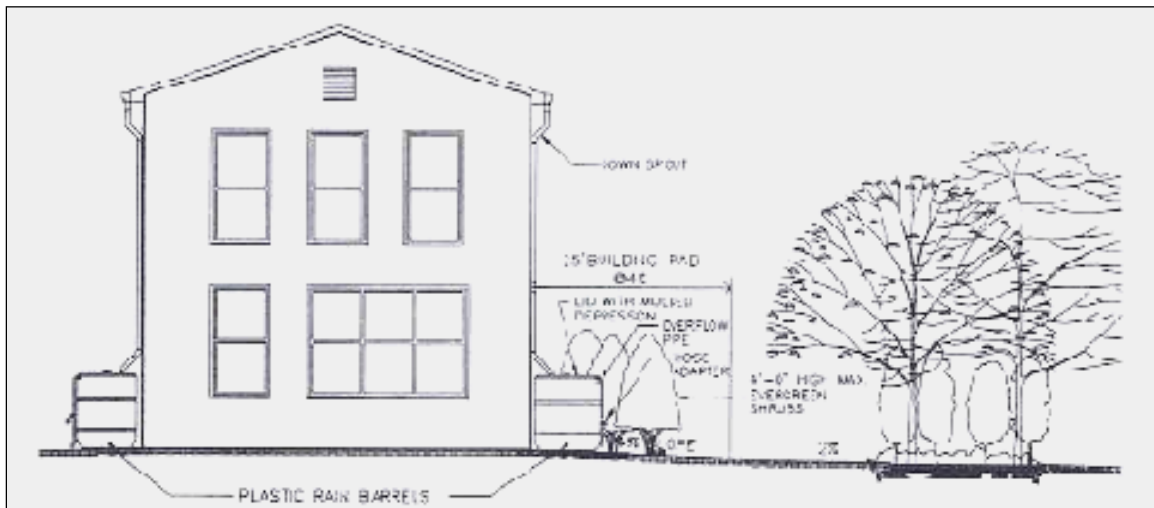

FIGURE 9. RAIN BARRELS

Cisterns

Cisterns are premolded plastic storage devices that are usually sited underground in proximity to rooftop downspouts. They function in a manner similar to rain barrels but offer storage capacities from 100 to 1,400 gallons. Water from cisterns is stored and released during dry periods, promoting water conservation for lawn and garden irrigation.

2.4 ADDITIONAL RESOURCES

Additional resources that provide detail on individual storm water management topics are listed below. The resources are not provided as endorsements, merely as educational and reference tools. Given regional variations in climate and land development needs, we have tried to include region-specific resources. It is important to note, however, that addresses, especially Internet links, are subject to change. This list contains the latest links and addresses as of the date of this publication.

Storm Water Management Manuals and Best Management Practices

City of Alexandria, Virginia

<http://ci.alexandria.va.us/solidwaste/stormwater.html>

Information on Virginia storm water ordinances and directions on acquiring publications such as *The Alexandria Supplement to the Northern Virginia BMP Handbook* and *The Virginia Storm Water Management Manual*.

City of Austin, Texas

<http://www.ci.austin.tx.us/watercon/default.htm>

Details of the city of Austin's Water Conservation Program as well as information about the city's rain barrel program (follow links to Single-family, Multi-family, and Commercial).

Friends of Bassett Creek, Minnesota

<http://www.mninter.net/~stack/bassett/gardens.html>

A comprehensive guide to the creation of rain gardens for runoff management, habitat creation, and aesthetic value is provided with design and construction information and recommendations on plant material.

F.X. Browne, Inc.

http://www.fx-browne.com/html/gs-facts/gs_primers.htm

A fact sheet entitled *Bioretention Systems for Storm Water Management* is available for downloading at the homepage of the F.X. Browne environmental consulting firm.

National Association of Home Builders

<http://www.toolbase.org/tertiaryT.asp?TrackID=&CategoryID=1438&DocumentID=2007>

An online report from the association's Technology Inventory entitled *Bioretention Sites for Storm Water Management* includes installation details, a short benefit/cost analysis, and a short list of bioretention links.

Pennsylvania Association of Conservation Districts

<http://www.pacd.org/products/bmp/bioretention.htm>

A Web site devoted to providing information on the bioretention BMPs for storm water pollution prevention.

Prince George's County, Maryland

<http://www.epa.gov/nps/lid/index.html>

The Prince George's County Maryland Department of Environmental Resources Programs and Planning Division (PGDER) created two publications with assistance from the U.S. Environmental Protection Agency (EPA): 1) *Low-Impact Development Design Strategies An Integrated Design Approach* (EPA 841-B-00-003), and 2) *Low-Impact Development Hydrologic Analysis* (EPA 841-B-00-002).

State of Maryland Department of Environment

<http://www.mde.state.md.us/environment/wma/stormwatermanual/>

This link provides updates on Maryland's Storm Water Management Program, including information on obtaining copies of *The 2000 Maryland Storm Water Design Manual (Vols. I & II)*.

State of Massachusetts Bureau of Resource Protection

<http://www.state.ma.us/dep/brp/www/wwpubs.htm#storm>

Downloadable versions of *Massachusetts Storm Water Policy Handbook*, *Storm Water Technical Handbook*, and *Storm water Management Policy*.

Storm Water Center

http://www.stormwatercenter.net/Assorted%20Fact%20Sheets/Tool6_Storm

[water_Practices/Filtering%20Practice/Bioretenion.htm](#)

A comprehensive document entitled *Storm Water Management Fact Sheet: Bioretention* provides detailed information on bioretention practices, including applicability, design considerations, and benefit/cost analysis.

Texas Natural Resources Conservation Service

<http://www.txnpsbook.org>

Texas Nonpoint Sourcebook, a site designed to provide storm water management information to public works professionals and other interested parties both in Texas and elsewhere, provides information ranging from basic to technical.

University of Washington Center for Urban Water Resources Management

<http://depts.washington.edu/cuwrw/>

A downloadable version of a publication from a research project investigating the use of permeable pavement entitled *The University of Washington Permeable Pavement Demonstration Project--Background and First-Year Results* is available under the Land Cover and Imperviousness section of the research link at the center's homepage.

U.S. Environmental Protection Agency

<http://www.epa.gov/owm/mtbfact.htm>

The Office of Wastewater Management in the Office of Water provides downloadable fact sheets on BMPs for urban storm water management, including bioretention, porous pavement, wet detention ponds, and more.

Washington State Department of Ecology

<http://www.ecy.wa.gov/biblio/9911.html>

The *Storm Water Management Manual for Western Washington* describes the storm water management standard for all new development and redevelopment projects in the Puget Sound area.

Organizations and Internet Resources

American Forests

<http://www.americanforests.org/>

The American Forests home page includes news, links, publications, and information on the use of trees to protect the environment. Included in the site is a link to the Trees, Cities and Sprawl section, which contains information and resources on urban forestry and resource protection.

American Society of Civil Engineers

<http://www.bmpdatabase.org>

The society and the U.S. Environmental Protection Agency provide an online, searchable database of over 90 studies evaluating the effectiveness of various storm water BMPs for surface water quality protection.

Center for Watershed Protection's Storm Water Center

<http://www.stormwatercenter.net/>

The Storm Water Center offers resources to assist decision makers and the public on storm water management issues. Resources include publications and manuals, slide shows, ordinance information, monitoring and assessment methods, and BMP fact sheets.

One publication, *Better Site Design: A Handbook for Changing Development Rules in Your Community*, could prove useful to municipal officials interested in revising their zoning ordinances.

Friends of the Rappahannock

<http://for.communitypoint.org/pages/LID.htm>

Friends of the Rappahannock, a nonprofit organization, highlights five existing commercial projects in the Fredericksburg, Virginia, area that were redesigned on paper to incorporate LID practices.

Low Impact Development Center, Inc.

<http://www.lowimpactdevelopment.org>

The Low Impact Development Center is a nonprofit water resources research group with a mission of conducting research and training on low impact development and sustainable storm water management. Publications, pictures, and other resources are available on the site.

Pennsylvania Housing Research/Resource Center

<http://www.engr.psu.edu/phrc>

Part of the Resource Center's work is in conducting research related to "smart growth" and sustainable site design. A workshop conducted March 2003 by Scott Brown entitled, "Understanding Management Practices for Post Construction Storm Water Control" provided information on the impact of development on runoff response.

Urban Land Institute

<http://www.uli.org>

The home page of the Urban Land Institute, an organization committed to providing responsible leadership in the use of land toward enhancing the environment, offers design resources for housing, retail, office, and transportation development.

U.S. Department of the Navy, Environmental Department

<http://www.nfesc.navy.mil>

A list of links to the Navy's pollution prevention program includes information about equipment, implementation, and planning. Also included is the Joint Service Pollution Prevention Library, a searchable database of prevention documents.

U.S. Environmental Protection Agency

<http://www.epa.gov/OW/index.html>

The Office of Water provides an immense amount of information on the protection and conservation of our nation's water resources.

Regional-Specific Resources

Northeastern United States

Cornell Cooperative Extension of Onondaga County

<http://www.cce.cornell.edu/onondaga/fingerlakeslan/default.htm>

The Web site presents information and design suggestions for landscaping property in a manner that reduces the risk of pollution to surface waters. The information is oriented to the Finger Lakes, New York region but is applicable to many other areas.

Minnesota Pollution Control Agency
<http://www.mnerosion.org/tools.html>

A comprehensive manual available online entitled *Protecting Water Quality in Urban Areas* highlights technical information about BMPs for protecting lakes, streams, and groundwater from storm water-related pollution.

New York State Department of Environmental Conservation
<http://www.dec.state.ny.us/website/dow/swmanual/swmanual.html>

The *New York State Storm Water Management Design Manual* provides designers with a general overview on how to size, design, select, and locate storm water management practices at a development site in compliance with state storm water performance standards.

Southeastern United States

Mississippi State University Agricultural and Biological Engineering Department
<http://abe.msstate.edu/csd/NRCS-BMPs/pdf/water/quality/bioretentsys.pdf>

A downloadable, two-page fact sheet providing descriptions and diagrams of a shallow-depression bioretention system.

Northern Virginia Regional Commission
http://www.novaregion.org/es_pubs.htm

A list of publications for purchase and downloading, including documents on BMPs such as *The Northern Virginia BMP Handbook* and *Nonstructural Urban BMP Handbook* and publications on Virginia's watersheds.

NRDC's Storm Water Strategies: Strategies in the Southeast
<http://www.main.nc.us/riverlink/content/07chap/chap07.htm>

Case studies for addressing storm water management techniques in new development and redevelopment.

Western United States

Built Green Colorado
<http://www.builtgreen.org/sites/green.htm>

The Built Green Colorado Web page with links to many green building resources. Built Green Colorado is a public/private partnership created to encourage home builders to use technologies, products, and practices that enhance energy efficiency, reduce pollution, provide healthier indoor air, reduce water usage, preserve natural resources, improve durability, and reduce maintenance.

Caltrans Storm Water Management Program
<http://www.dot.ca.gov/hq/env/stormwater/index.htm>

Information on current monitoring studies, publications, conferences, and links are presented in the context of California's Storm Water Management Program. The site is oriented to reducing the impact of California roadways on aquatic resources.

City of Seattle
<http://www.ci.seattle.wa.us/util/surfacewater/bmp/default.htm>

Information on simple and effective BMPs for homeowners and businesses provided by

Seattle Public Utilities. The information includes everyday tips for protecting surface water.

U.S. Environmental Protection Agency Region 10

<http://www.epa.gov/region10>

The Region 10 home page provides general information on the region's resources as well as links to its programs. This site also includes regularly updated information on environmental issues in the local news.

Utah Association of Conservation Districts

[http://www.ci.north-](http://www.ci.north-logan.ut.us/Information/Low%20Impact%20Report/Low%20Impact%20Report.html)

[logan.ut.us/Information/Low%20Impact%20Report/Low%20Impact%20Report.html](http://www.ci.north-logan.ut.us/Information/Low%20Impact%20Report/Low%20Impact%20Report.html)

The community of North Logan developed LID roadway design standards. The site includes documentation of the process, exhibits, standards, and specifications.

Southwestern United States

Arizona Department of Water Resources

<http://www.adwr.state.az.us/>

A variety of information on all aspects of water resources for the state of Arizona.

Pima County Department of Environmental Quality

<http://www.deq.co.pima.az.us/water/storm.htm>

Provides information on Tucson and the surrounding area's storm water management program and components.

Pima County Flood Control District

<http://www.dot.co.pima.az.us/flood/wh/index.html>

Methods for collecting, storing, and distributing rainwater to reduce residential runoff loads as well as information on harvesting system maintenance.

SECTION 3: WASTEWATER TREATMENT



Properly designed, installed, and maintained on-site wastewater treatment systems can cost effectively treat wastewater and protect the watershed from pollutant overloads.

3.1 INTRODUCTION

Section 2 addressed storm water management issues and explained how rainwater could be used as an asset instead of viewed as a liability in new developments. As we mentioned in Part I, we have expanded LID to include wastewater management. We now turn to the methods and systems that developers can use for effectively treating wastewater generated at residential sites.

It is becoming increasingly popular to protect the nation’s surface water and groundwater and prevent further stress from a variety of pollution sources. Approximately 300,000 miles of rivers and shorelines and approximately 5 million acres of lakes are polluted by harmful microorganisms, sediment, and excess nutrients.

(<http://www.epa.gov/owow/tmdl/overviewfs.html>). Wastewater can contain nutrients (e.g., nitrogen, phosphorus), pathogens (e.g., disease organisms), and chemicals (e.g., ammonia, medical byproducts). Thus, developers must ensure that equipment and management methods effectively treat wastewater before it is released into the environment.

Table 11 lists current conventional wastewater management practices and technologies and the alternative systems discussed in this chapter. The 1993 *HUD Proposed Model Land Development Standards and Accompanying Model State Enabling Legislation* publication addressed some of the conventional technologies, which are briefly noted below. To put current technology use into perspective, Figure 10 shows that a vast majority of homes in the United States rely on municipal sewer systems.

Wastewater Management Options Discussed in Chapter	
Conventional	Alternative
Municipal Sewer	Aerobic
Single Septic	Sand Filters
Community Septic	Mound
Combined On-Site Systems and Sewer	Trickling Filter
Storage and Removal	Evapotranspiration
	Low-Pressure Pipe

TABLE 11. WASTEWATER MANAGEMENT OPTIONS

Although only 23 percent of homes in the United States are on individual septic systems, such systems can be a significant source of water pollution. Moreover, the average age of a home with a septic system exceeds 30 years. Further, of those homes on septic systems, an estimated 403,000 experienced system breakdowns in a three-month period in 1997 (Bureau of the Census, 1999).

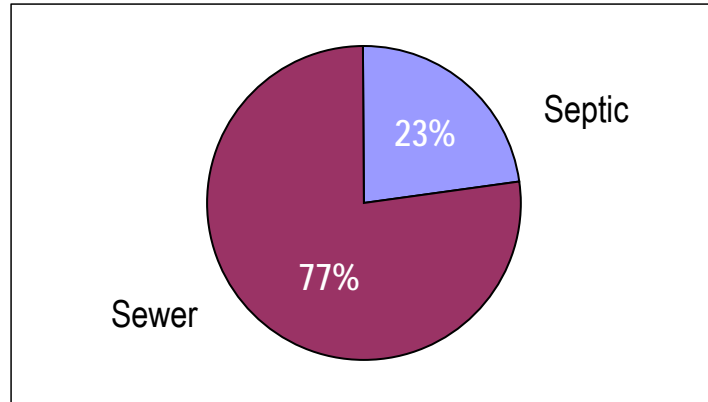

FIGURE 10. HOW HOMES HANDLE WASTEWATER

The management of residential wastewater is a process fraught with technological and regulatory issues. For instance, some communities limit the use of traditional septic systems because improperly maintained systems can release untreated effluent into the soils; in other instances, communities have experienced a number of system malfunctions. Effluent contains excess nutrients and harmful organisms that can adversely affect water quality. Regulatory officials respond to the need to protect our water by adopting progressively stringent wastewater treatment regulations. More specifically, in some cases, communities turn to rigorous regulation of conventional systems as a means of curtailing development, yet they fail to recognize that water quality issues can be addressed by using alternative wastewater management systems.

It is important to keep in mind that septic systems are still used effectively and approved throughout the country. However, in response to the problems noted above, private industry continues to develop alternative systems designed to overcome some of the issues that can plague the performance of conventional septic systems.

This chapter briefly describes the environmental, cost, and regulatory issues associated with wastewater treatment. It then explains how conventional residential developments deal with wastewater management. The last part of the chapter discusses some of the more common alternative means of wastewater management. Table 12 presents the chapter's overall objectives.

<p>Objective 1:</p> <p>Explain how the use of alternative systems and combinations of systems can reduce on-site infrastructure costs and loadings to municipal sewer systems.</p> <p>Objective 2:</p> <p>Demonstrate alternative lot and site layouts to accommodate a variety of system types.</p> <p>Objective 3:</p> <p>Show how the use of alternative systems and combinations of systems can reduce pollutant loadings to waterways.</p>
--

TABLE 12. WASTEWATER MANAGEMENT OBJECTIVES

3.1.1 ENVIRONMENTAL ISSUES

LID is an approach that uses technologies to simultaneously conserve and protect natural resource systems and reduce infrastructure costs. Wastewater can affect natural resources; all wastewater coming from a home must be sent to an effective treatment site or public treatment system in order to limit adverse environmental and health impacts. One of the reasons that public officials prefer to rely on municipal sewer systems for wastewater treatment is that many of the systems are operated by trained technicians who

continuously monitor the treatment process to ensure that discharge waters meet local permit or other regulatory requirements.

- Heavy Equipment--Heavy-duty trucks and other equipment passing over a septic system or drainfield may damage the pipes or system parts.
- Clogging--Systems are designed to keep solids, e.g., sludge and scum, out of the final effluent. However, if those elements make it to the drainage field, they can cause premature soil clogging such that the effluent from the septic tank has trouble percolating into the soil and can pond.
- Roots--Tree and bush roots can enter the system. It is essential to keep large plants away from the septic system.
- Improper Sizing/Design--The system must be large enough for the load and installed in suitable soils as well as in as shallow a trench as possible so that it does not interfere with groundwater.
- Improper/Lack of Maintenance--Septic systems need routine maintenance, including tank pumping and cleaning and inspection by a licensed professional. Properly maintaining a tank keeps solids from accumulating and clogging the leach field.

TABLE 13. COMMON REASONS FOR SEPTIC SYSTEM FAILURE

In most cases, wastewater treatment can be handled by one of the four conventional methods noted in Table 11. However, there are exceptions. For instance, in some circumstances, sewer systems cannot be used because of cost considerations; it might be too costly to run pipes long distances to link a proposed development's wastewater system to existing municipal sewer connections. In other cases, a municipality might have specific health or environmental concerns that make the use of septic systems unacceptable.

Nitrogen and phosphorus are two nutrients in wastewater that, either in excess or through cumulative effect, can adversely affect receiving waterbodies. When septic systems fail to operate as designed, excess nutrients in untreated wastewater can enter the environment. Excess nitrogen in streams, lakes, and estuaries stimulates the growth of plants (algae and phytoplankton). Algae in turn consume oxygen, and the decomposition of dense algal blooms leads to anoxia (no oxygen) and hypoxia (low oxygen). Eventually, the aging process of the waterbody is accelerated through a complex chain of events known as eutrophication. Indicators of eutrophic conditions include odors, poor water clarity, stressed marine organisms, and, in severe cases, dead fish.

From a public health point of view, conventional septic system failure is one of the main reasons for increased interest in alternative on-site wastewater treatment systems. Table 13 lists some common causes of septic system failure. Conventional septic system failures potentially can contaminate groundwater and surface water with bacteria harmful

to humans. Further, septic systems with poor nitrogen removal can overload nearby waterways, resulting in algal blooms and adverse impacts on aquatic life.

Numerous communities nationwide are attempting to address general water contamination and, in particular, nitrogen loading. For instance, when studies showed that septic systems were threatening groundwater supplies in the Los Angeles area, the Los Angeles Regional Water Quality Control Board voted in 1999 to prohibit the installation of any new septic systems in Ventura County and required the use of septic systems to cease by January 1, 2008 (California EPA Press Release, August 17, 1999). Studies showed that the prohibition was necessary to safeguard the public health and protect the local water supply; community drinking water is pumped from groundwater beneath the discharge area of the septic systems. As part of its overall water conservation plan, Milford, New Hampshire, prohibits septic system use near waterbodies (<http://www.ci.milford.nh.us/conservation/streams.html>). The Chesapeake Bay watershed is an area greatly affected by water pollutants. The Chesapeake Bay Program, which is designed to protect the bay, determined that between 55 and 85 percent of the nitrogen entering an on-site wastewater treatment system could be discharged into groundwater (U.S. Environmental Protection Agency, 1993). As noted in a U.S. Environmental Protection Agency (EPA) report, "Hydraulically functioning systems can create health and ecological risks when multiple treatment units are installed at densities that exceed the capacity of local soils to assimilate pollutant loads" (U.S. Environmental Protection Agency, 2002). Thus, the concern over septic systems extends to both the inability of septic systems to remove nitrogen and the increased number of septic tanks installed in any one area.

Phosphorus is another nutrient that, if discharged from septic systems, can lead to eutrophication of nearby waterbodies, although it is considered less of a threat than nitrogen to groundwater and surface contamination via conventional septic systems. Septic systems are generally effective in adequately removing phosphorus; furthermore, soil particles adequately adsorb soluble phosphorus and extract soluble phosphorus compounds from septic tank effluent as it leaches through the soil profile, thus limiting the movement of phosphorus through the soil.

3.1.2 COST ISSUES

Municipal Sewer Connection Fees

In addition to environmental issues, economic factors play a role in the selection of an appropriate wastewater treatment system. To connect a home or community to a municipal sewer system, developers must pay certain fees. A community that operates a municipal sewer system often combines the potable water tap fee with the sewer connection fee. In addition, communities sometimes charge developers impact fees to help offset new homeowner impacts on community resources.

Impact fees are not new; they have existed since enactment of the Standard Planning Enabling Act of 1922. However, both the number and dollar amount of impact and connection fees have risen dramatically since the early 1900s. In some communities, sewer connection fees have risen to help municipalities pay for system operation and maintenance costs and system expansions. Fees can range from \$1,500 per house to over \$14,000 per house. Fee increases have exacerbated the affordable housing problem

currently plaguing portions of the United States. In a related matter, some communities report that their wastewater treatment facility is at or near capacity, hindering further residential development until facility expansion can accommodate additional growth. In response, HUD's Office of Policy Development and Research created the Regulatory Barriers Clearinghouse to examine how impact fees and other issues affect the creation and maintenance of affordable housing (<http://www.huduser.org/rbc/>).

Conventional Septic Installation and Maintenance Costs

The cost of installing septic systems depends on system size, treatment capacity, occupancy, and land issues such as the type of on-site soil. For example, in Minnesota, the costs of installing a septic system can range from \$2,000 to \$7,000. The average cost to pump the tank's sludge ranges from \$75 to \$150. Pumping the tank at the appropriate frequency is less costly than replacing the system's leach field, which would be needed if solids enter the field from an overloaded septic tank. If a septic system and corresponding leach field need to be replaced in Minnesota, the costs are equal to that of installing a new system -

<http://www.extension.unm.edu/distribution/naturalresources/components/DD6946c.html>.

3.1.3 REGULATORY ISSUES

Currently, most local regulations are prescriptive and limit the introduction and use of alternative on-site wastewater treatment systems (OWTS). Public health officials, however, can facilitate the use of alternative OWTSs by revising the applicable codes.

The use of alternative systems can reduce the capacity strain on an existing wastewater treatment facility. In fact, some local officials may be willing to allow alternative OWTSs on some but not all lots within a parcel. For instance, some lots may have the appropriate soil composition for the use of conventional septic systems while the soils on other lots in the development may not lend themselves to such systems. Thus, a community that needs to increase the capacity of the local wastewater treatment system could allow a mix of alternative and traditional OWTSs on a single site instead of relying exclusively on alternative systems. This is an example of how LID is flexible in its application.

3.1.4 GENERAL PERFORMANCE STANDARDS

In general, wastewater treatment systems take in wastewater, treat it, and release it to the environment. It is difficult, however, for prescriptive codes to specify the full range of technological options appropriate for a given site and anticipate the different sensitivities of the site's water and land resources. Although the topic is beyond the scope of this publication, public officials could use performance codes to address site-specific natural resource needs while meeting health requirements.

In 2002, the National On-Site Wastewater Recycling Association (NOWRA) received a grant to develop draft national on-site performance standards (http://www.nowra.org/model_code.html). The underlying issue and impetus for the project is that local wastewater regulations are usually prescriptive. Although alternative OWTSs have worked elsewhere in the country, local code officials are often reluctant to approve the use of these systems in their jurisdiction when a site does not meet the

prescriptive requirements. The goal of the NOWRA project is to create a set of national OWTS standards that local officials could use for approving the use of innovative systems (Small Flows Quarterly, Winter 2002).

The U.S. EPA states in a March 28, 2003 Federal Register notice regarding Voluntary National Guidelines for Management of On-site and Cluster (Decentralized) Wastewater Treatment Systems, “State agencies report that some of these systems have failed because of inappropriate siting or design or inadequate long-term maintenance. Historically high failure rates in some areas indicate a need for better management of these systems to protect public health and water quality.” U.S. EPA has thus developed the Management Guidelines that are designed to enhance system performance through improving the quality of management programs (Federal Register, 2003). You may access this Federal Register notice electronically through the EPA Internet under the Federal Register listings at <http://www.epa.gov/fedrgstr/T>.

3.2 CONVENTIONAL APPROACHES TO WASTEWATER TREATMENT

Developers typically have four options regarding residential wastewater treatment systems: tying into a municipal or public sewer system, providing homeowners with an on-site septic system, using a community septic system, or using a combination of on-site systems and tying into the municipal system. Centralized municipal systems, often available in urban and many suburban areas, are often the most cost-effective option when municipal system connections are proximate to the land to be developed. Municipal systems consist of a series of pipes and pump stations leading to a wastewater treatment facility. The facility treats the water before releasing it to a body of water. In many instances, however, homes in a development cannot connect to a municipal treatment system. It may be cost-prohibitive to connect to a municipal system because of distance to conveyance pipes, or a municipal system already at capacity cannot treat additional effluent. In these cases, developers have traditionally turned to septic systems.

A conventional septic system normally treats a home’s wastewater in an underground septic tank located on the property. The life of septic systems depends on the quality of the installation, correct usage, and the frequency of maintenance. With appropriate maintenance, many systems can last for 20 years or more.

Two primary factors in a septic system’s successful operation include proper installation and appropriate operation and maintenance. Assuming proper installation, homeowners must ensure that the tank is pumped out as frequently as needed. In addition, given that the bacteria within the tank are sensitive to the wastewater inputs, homeowners should not use the system for the disposal of chemicals such as turpentine, alcohol, and bleach as well as for large volumes of grease and animal fats; such items can clog the system. Developers should provide homeowners with a list of “things to do and not to do”. The National Small Flows Clearinghouse sells *The Homeowner On-Site System Recordkeeping Folder* (Item #WWBLPE37) and the *Homeowner Septic Tank Information Package* (Item #WWPKPE28) to help homeowners record and store information about their septic system and to educate homeowners on system care and system (http://www.nesc.wvu.edu/nsfc/nsfc_septicnews.htm#septic). In addition, the U.S. EPA has created a free, one-page Homeowner Septic System Checklist to highlight the homeowner’s septic system maintenance needs (U.S. EPA, 2003).

Another wastewater management option sometimes used by developers is a communitywide wastewater treatment system. Although the vast majority of today's homes either use single septic systems or are connected to public sewer, some developers have installed communitywide septic systems. The systems treat wastewater for a group of homes in a manner similar to a septic system for a single home. Small community cluster systems often try to take the best attributes of municipal sewers and septic systems and use them to reduce wastewater treatment system installation costs while meeting environmental goals. The systems transport wastewater from homes via sewer pipes to either a conventional treatment plant or a pre-treatment facility. The effluent is then discharged to soils similar to those required in the last stage of a single septic system's treatment process.

Some communities install a centrally located package wastewater treatment plant that connects each home in that community to the plant. The package system is similar to public wastewater treatment facility except that the effluent from the homes travels to a privately owned and operated treatment plant located in the community (sometimes referred to as "small community sewer" or "distributed sewer").

A small number of jurisdictions are using natural open spaces, golf courses, and soccer fields as areas for drip irrigation of semitreated effluent. Such uses of open space allow effluent to be effectively disposed of across large areas. Another benefit of is that the systems can be created as needed. The developer can calculate how much effluent the entire development will likely generate and then phase in the system as homes are built. The system's potential drawbacks include a perception that odor will be a problem or that public health will be compromised.

In several communities, community systems have proven themselves a feasible alternative. For example, in Warren Village, Vermont, nearby streams had become polluted in part because of a combination of dense development, small lot sizes, and failed single septic systems. When residents determined that a municipal sewer system was too expensive, the town used two parcels--a soccer field and a vacant lot-- as common leaching fields with a total capacity of 30,000 gallons per day. Homeowners whose lots lacked adequate wastewater disposal capacity could pay the newly formed wastewater management district \$250 per user per year to discharge to the community system (<http://www.daylor.com/projects/Gloucester/CommunityWastwater.htm>).

Community systems can also facilitate the use of smaller house lots. Single septic systems need an adequate land area for the leach field. With community systems, the final treatment location is consolidated into one large leach field instead of relegated to several individual fields. Allowing for smaller lots can help the developer preserve open space, furthering the goals of low-impact development.

Some instances warrant a combination of sewer hook-up and septic system installation. . For example, a municipal sewer system may be able to serve only an additional 50 homes, yet a proposed development calls for 200 homes. Public officials and the developer might agree to hook up 50 of the new homes to the public system and serve the rest of the homes with an on-site septic tank system.

A combination system might also be warranted when soils on part of the development are not suitable for septic tank installation. In this instance, the lots that cannot accommodate

septic systems could be connected to the municipal system while the rest of the lots could be served by septic systems or municipal connections.

Clearly, each parcel of land is often suited to a variety of options available to the developer. Developers can help create cost-effective developments by weighing all the wastewater management options and determining which will yield the best performance at the least cost. The LID approach helps increase the number of wastewater management system options available to the developer.

3.3 ALTERNATIVES TO CONVENTIONAL SYSTEMS

Table 14 contains a brief description of the OWTSs highlighted in this chapter. Listed below are expanded explanations of the alternative systems that provide secondary treatment and that might allow for on-site wastewater treatment (U.S. Environmental Protection Agency, 2002).

OWTS Type	Key Components	Situations Where Its Use Might Be Appropriate
Sand Filters	<ul style="list-style-type: none"> Septic tank, sand filter, and sometimes a recirculation tank 	<ul style="list-style-type: none"> Where soil conditions do not allow for percolative beds/trenches High groundwater
Mound	<ul style="list-style-type: none"> Pre-treatment unit(s), dosing (pumping) chamber, and elevated mound 	<ul style="list-style-type: none"> Slow- or fast-permeability soils Shallow rock cover over creviced or porous bedrock High groundwater
Trickling Filter	<ul style="list-style-type: none"> Circular bed of coarse or plastic material and rotating distributor 	<ul style="list-style-type: none"> High concentrations of organic material in wastewater
Evapotranspiration	<ul style="list-style-type: none"> Pre-treatment unit, evapotranspiration sand bed, bed liner, fill material, monitoring, overflow protection, and surface cover 	<ul style="list-style-type: none"> Annual evaporation rate exceeds annual rate of precipitation and wastewater applied
Low-Pressure Pipe	<ul style="list-style-type: none"> Septic tank, pumping (dosing) chamber, and small-diameter pipes 	<ul style="list-style-type: none"> Where soils would become clogged as a result of localized overloading High groundwater Anaerobic conditions due to continuous saturation
Aerobic	<ul style="list-style-type: none"> Aeration compartment, settling chamber, pre-treatment compartment (optional) 	<ul style="list-style-type: none"> Where septic systems have failed Where lot size is not sufficiently large to accommodate a standard septic system drainfield
Proprietary Systems	<ul style="list-style-type: none"> Varied 	<ul style="list-style-type: none"> Where conventional septic systems or sewer hook-ups are not feasible

TABLE 14. ON-SITE WASTEWATER TREATMENT SYSTEM ALTERNATIVES

Alternative systems can use anaerobic bacterial action, i.e., the bacteria decomposes waste in the absence of oxygen, while other systems need oxygen (i.e., aerobic) to operate properly. In addition, hybrid systems use a combination of aerobic and anaerobic processes.

Developers can consider a variety of on-site wastewater treatment system options either as alternatives or enhancements to conventional septic systems. By using the LID approach, developers often uncover information and options that can help facilitate the development approval process.

While municipal sewer or on-site septic systems may be the most recognized wastewater treatment options, some sites might lack both sewer access *and* the ability to accommodate a septic system. Some of the limiting factors for septic systems include lot size (an ample soil absorption field is necessary), groundwater level, depth of bedrock, and on-site soil types. For example, dense clay or rocky soils can inhibit the use of septic systems. Recognition of various limitations has led to increased interest in and the development of alternative on-site wastewater treatment systems.

Alternative on-site wastewater treatment systems range from adding treatment steps (e.g., intermittent sand filter) to a conventional septic system to the reliance on proprietary systems that omit the use of traditional septic tanks. In fact, as technology grows more sophisticated, it is often more important to establish an operation and maintenance plan for an alternative OWTSs than for an ordinary septic system.

<p>Examples Where a Septic System May Not Be Allowed on a Lot</p> <ul style="list-style-type: none">Lot size too smallWrong types of soilsHigh groundwater levelShallow soils/Depth of bedrockSteep slopesSoil does not percolate
--

When lots cannot be developed to take advantage of conventional wastewater management techniques (e.g., municipal sewer or on-site septic systems), the use of alternative OWTSs (discussed below) can make those lots suitable for development. Before using an alternative OWTS, however, developers are advised to familiarize themselves with the local public health criteria related to wastewater effluent and to recognize that, as opposed to municipal sewer systems, which are usually regulated by codes at the state level, local public health officials regulate on-site systems. The lack of information on the systems and absence of third-party verification of alternative system performance make public health officials reluctant to alternative OWTS. In general, public officials are most concerned with ensuring a certain level of public health, not with facilitating land development; therefore, officials often need to be educated about the efficacy of alternative systems.

On a related note, some public officials and environmental groups have expressed concern that the use of septic and/or alternative OWTSs will foster sprawl. The use of OWTSs by themselves does not lead to unchecked growth; indeed, the best way to manage growth effectively is through prudent zoning, not by eliminating potential wastewater treatment solutions or creating barriers for the adoption of alternative technologies related to development.

3.3.1 PROCESS FOR IDENTIFYING POTENTIAL ON-SITE WASTEWATER TREATMENT SYSTEM ALTERNATIVES

Each parcel of land is unique in terms of its size, shape, and soil types. If public health officials indicate that an alternative OWTS is a feasible option, then developers should consider several factors to identify the types of systems that might be used. For instance, OWTSs are more complex than septic systems and thus require a higher level of maintenance and supervision and may need additional excavation during installation to accommodate the various systems' several components. Table 15 briefly describes the various factors to be considered.

Costs can vary for different OWTS options. For instance, community wastewater treatment systems that rely on gravity to transport wastewater can require deep and thus costly excavations, but the use of pressurized systems with small-diameter plastic pipes can minimize excavation costs.

Some OWTS alternatives to conventional systems, such as recirculating sand filters and evapotranspiration systems, are “add-ons” to a traditional septic tank system. The additional treatment unit is connected in-line with the septic tank and provides an extra level of treatment. Although it may seem more costly to add another layer of treatment, alternative treatment systems may be less costly if conventional wastewater management methods require the hauling of extra fill material or the construction of a retaining wall.

As for other cost issues, alternative OWTSs may need electricity to operate the pumps that are sometimes required as part of the treatment system itself and that are sometimes needed to move wastewater from the house to the treatment area. In addition, the inclusion of other features such as recirculation piping, aeration, and an increased need for cleaning/pumping may increase an alternative system’s operation and maintenance costs.

Another economic issue associated with the use of an alternative OWTS is the long-term operation and maintenance (O&M) costs and related organizational framework required

- **Aesthetics**--Both the general public and public officials will be most aware of aesthetic concerns. In short, potential insect problems and odor issues must be addressed and mitigated.
 - **Capacity**--The system must be able to handle the home’s capacity; the approval process will consider both rate and volume of sewage flow. In addition, public officials may want the system to be able to handle more than the current load to accommodate changing uses of the home.
 - **Cost**--The upfront costs of alternative OWTSs can often be higher than the costs of traditional septic systems. In addition, the complexity of alternative systems yield somewhat higher operation and maintenance costs (e.g., the alternative systems usually need electricity to treat waste).
 - **Efficiency and Reliability**--The community at large will be interested in any third-party reports and data indicating how well the proposed systems treat or remove potentially harmful wastewater components. In addition, the system must have adequate safeguards to warn the occupant of system failure.
 - **Environmental and Public Health**--A system must maintain or improve environmental quality and adequately address public health issues.
 - **Operation and Maintenance (O&M)**--As an emerging issue in the on-site wastewater treatment field, OWTSs require more monitoring than standard septic systems; thus, the local jurisdiction or a third party must ensure the proper maintenance of equipment.
 - **Siting**--Soil type and lot size are often determining factors when siting OWTSs. For instance, only about one-third of the land area in the United States has soils suitable for conventional subsurface soil absorption fields.
- Source: U.S. EPA, 2002.*

TABLE 15. FACTORS TO CONSIDER WHEN EVALUATING ON-SITE WASTEWATER TREATMENT SYSTEMS

with the systems. Given that innovative systems usually require more frequent and ongoing O&M than conventional systems, developers, public officials, and communities must work together to develop an O&M plan and establish an entity that will ensure

effective system performance. Such an entity can oversee O&M activities, reduce liabilities, and establish service boundaries (Jones et al., 2001).

The following list offers criteria for determining situations in which an alternative OWTS could be most helpful:

- **When sewer is not located nearby.** If a given plot of land is not located close to existing infrastructure, thus making it costly to establish public sewer connections, then OWTS might be an effective option.
- **When the wastewater treatment facility is at capacity.** In some locales, the wastewater treatment facility is at capacity and cannot accept any more connections. In these instances, either a new facility will have to be built or the existing facility will have to be expanded. Either option will require the public's investment and time and will potentially delay land development.
- **When a lot is too small.** If local ordinances dictate that a lot is too small to accommodate a septic field, an alternative OWTS might help reduce the size of the required absorption field.
- **When a watershed requires higher-quality effluent.** In some instances, a watershed has effluent requirements that exceed the effluent characteristics normally produced by septic systems. Once again, the enhanced wastewater treatment available with some alternative OWTSs may help provide a solution.
- **When groundwater supply is limited.** Instead of pumping water off site through a sewer, an OWTS keeps water on the site; properly treated effluent from an alternative OWTS can help recharge the local groundwater aquifer.
- **When deep excavation is needed for a septic system.** Some alternative systems do not require as much excavation as septic systems, thus reducing initial costs.

Another way to look at the system selection process is through a variety of stakeholders' lenses. Figure 11 provides an overview of some of the groups interested in the process of selecting an appropriate OWTS and their relevant concerns (U.S. Environmental Protection Agency, 1997).

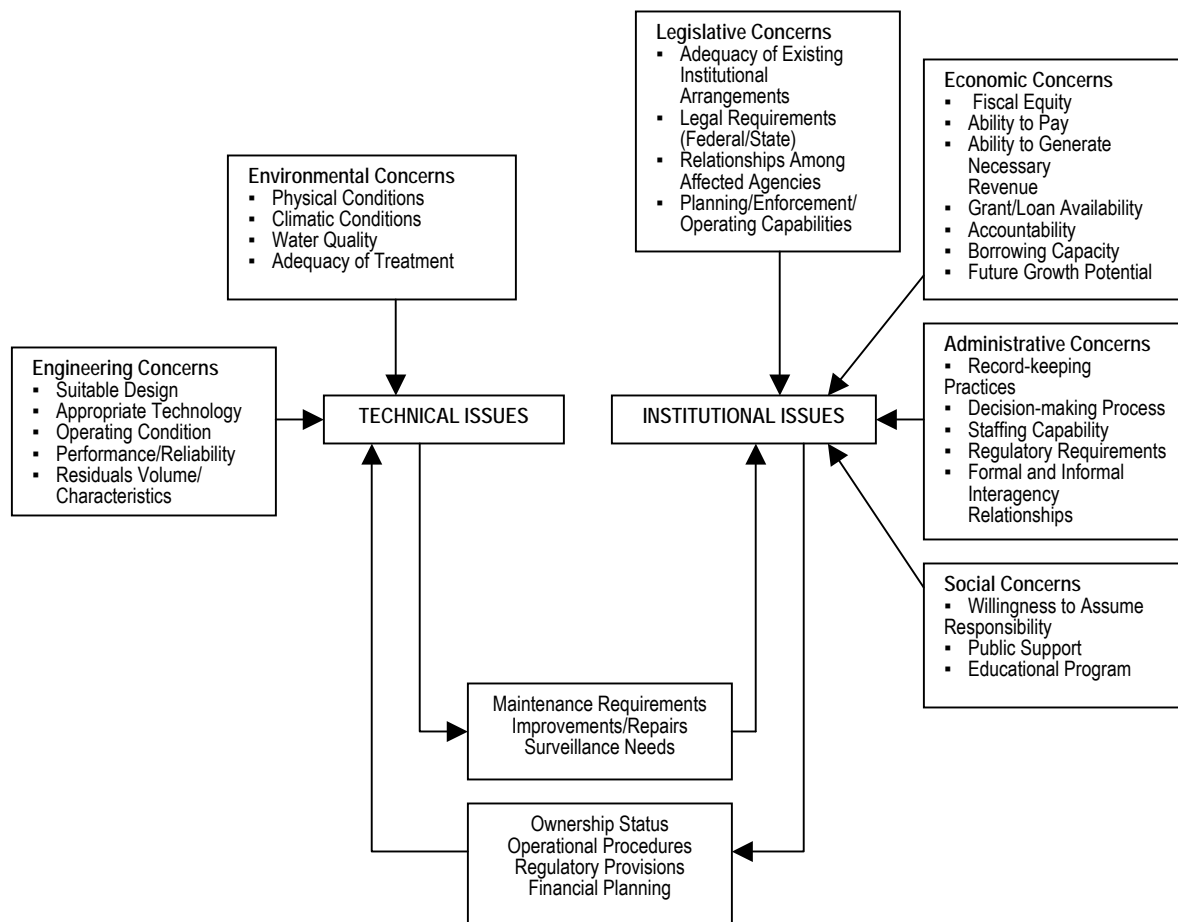

Source: Response to Congress On Use of Decentralized Wastewater Treatment Systems, <http://www.epa.gov/owm/decent/response>.

FIGURE 11. OVERVIEW OF PARTIES INTERESTED IN WASTEWATER TREATMENT DECISION MAKING

In some situations, conditions do not permit the installation of septic systems, particularly if soils are not appropriate or lot sizes are not sufficiently large to support a leach field. For example, the Floyd County, Kentucky, Plan Commission recently proposed a zoning ordinance amendment that would use soil conditions to dictate how many homes could be built per acre with septic systems (*The Courier-Journal*, Louisville, KY, May, 2002). In the worst soil and topographic conditions, the proposed amendment would limit development to one house with a septic system per 20 acres.

As previously noted, there are a variety of alternative systems available to developers. Below are descriptions of the different systems. Also included are considerations developers can take into account when deciding which systems to include in a new development.

3.3.2 SAND FILTERS

Intermittent Sand Filters

Sand filter systems treat the effluent downstream from a conventional septic tank. Two of the more common sand filter systems are the single-pass system (i.e., intermittent) and the recirculating system. In the single-pass system, the wastewater first undergoes primary treatment in a septic tank. The effluent is then applied intermittently to the top of a bed of sand (or other suitable media) that sits on an impermeable liner and percolates through the sand into drains located at the bottom of the bed (see Figure 12). As the wastewater passes through the sand filter, both physical and chemical processes treat the effluent, although microorganisms attached to the fixed media primarily treat the effluent. The effluent is then piped to the leach field for further treatment and disposal. Bottomless systems have no impermeable liner and do not discharge to a drainfield but rather to the soil below the filter.

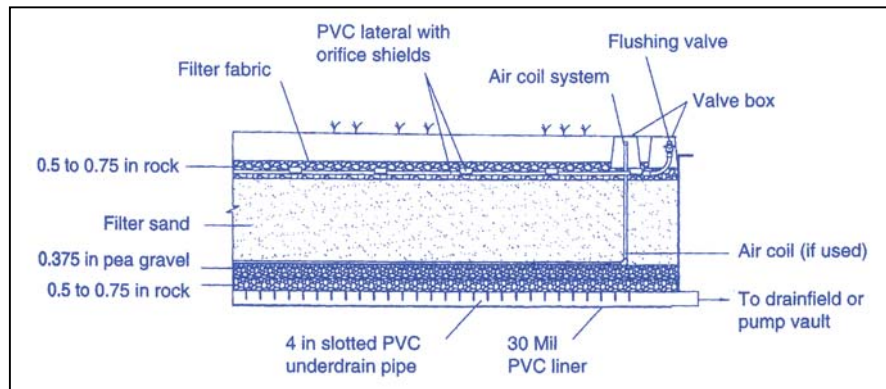

Source: *National Small Flows Clearinghouse Fact Sheet, 1998.*

FIGURE 12. TYPICAL CROSS-SECTION OF AN INTERMITTENT SAND FILTER

Intermittent sand filters produce a high-quality effluent by removing a high percentage of contaminants. The filter's ability to perform adequately depends on the filter's design and composition and, hence, the biodegradability of the wastewater and the environmental factors within the filter. The most important environmental factors include media re-aeration and temperature. Re-aeration makes oxygen available for the wastewater's aerobic decomposition. Temperature directly affects the rate of microbial growth, chemical reactions, and other factors that contribute to the stabilization of wastewater within the system.

System pumps and controls should be checked every three months while the sludge build-up in the septic tank should be checked as needed. Installation costs of intermittent sand filters, including labor and materials, generally range from \$7,000 to \$10,000. Daily energy costs for pumping the wastewater onto the filter bed run between \$0.03 and \$0.06.

Recirculating Sand Filters

In situations without sufficient land area for a single-pass filter system, recirculating sand filter systems are an option. In a recirculating system, wastewater first undergoes treatment in a septic tank. The pre-treated effluent then flows into a recirculation tank

along with some of the water that has already passed through the sand filter. A pump transports the wastewater mixture from the tank to the sand filter, where microorganisms attached to the filter media carry out treatment. The treated effluent collects at the bottom of the filter; some of the effluent is sent back to the recirculation tank for further treatment and some is sent out for disposal or another type of treatment disinfection. In this type of system, the sand is periodically changed (see Figure 13).

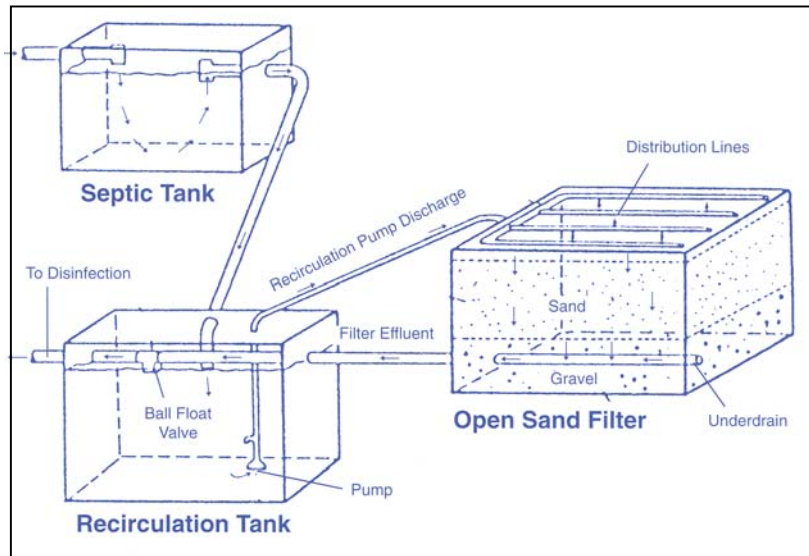

Source: National Small Flows Clearinghouse Fact Sheet, 1998.

FIGURE 13. TYPICAL RECIRCULATING SAND FILTER SYSTEM

Recirculating sand filters are relatively low-maintenance systems whose operating costs are generally modest. Operation and maintenance costs were under \$5,000 for a 135-home septic tank system in Elkton, Oregon, including \$780 for electricity and 25 to 30 labor hours per month. The replacement of the media represents one of the system's most expensive maintenance items. Thus, it is prudent to use locally available materials. For example, the capital cost (land not included) for a 5,000 gallon per day system with black beauty™ sand media that was not locally available totaled about \$68,600. That same system cost \$36,000 with standard sand media.

- Peat Filters--Organic particles and suspended solids are removed by passing wastewater through a peat bed.
- Batch Reactors--To increase nitrogen-removal efficacy, batch reactors alternate between oxygen-rich and oxygen-poor cycles and treat one batch of wastewater at a time.
- Activated Sludge Systems and Aerobic Treatment--Biooxidation (aerating wastewater) and oxygen-poor settling areas improve treatment.

TABLE 16. SECONDARY TREATMENT

Other types of filters provide secondary wastewater treatment (see Table 16).

3.3.3 MOUND

On lots with high water tables or soils unsuited to septic systems, a mound of suitable soils is placed on top of the soils that do not permit the use of a septic system. The primary treatment takes place in the septic tank. The wastewater from the tank passes

through a filter (to eliminate additional solids) and discharges to a dosing chamber. The effluent is then spread uniformly on the mound, which acts as an elevated or above-ground drain field. Typically, a mound system requires a pump that sends the effluent from the septic tank upward into perforated pipes that are located in the mound within a layer of fabric-covered coarse-gravel aggregate. The mound is often a soil cover that can support vegetation (see Figure 14).

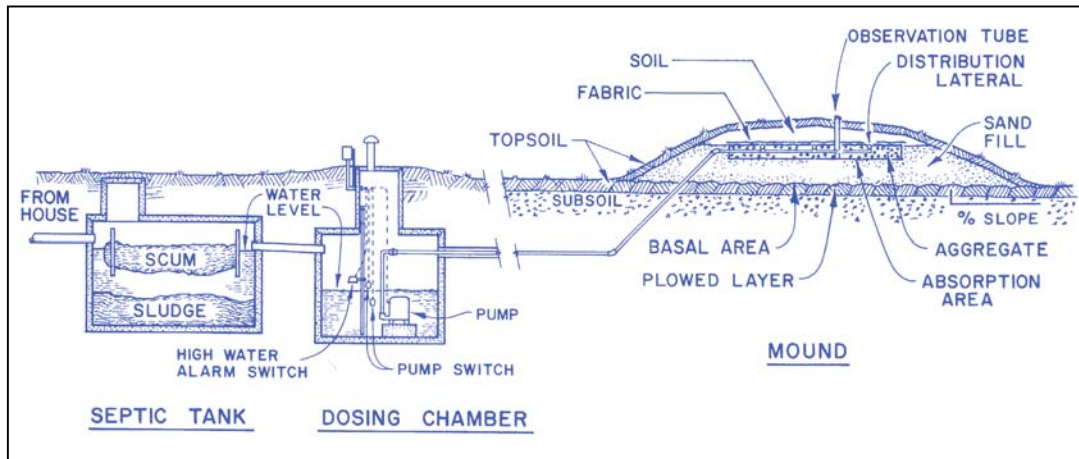

Source: *National Small Flows Clearinghouse Fact Sheet, 1998.*

FIGURE 14. SCHEMATIC OF A WISCONSIN MOUND SYSTEM

The mound's height should be sufficient to treat the effluent effectively before it reaches the limiting soils, bedrock, or high water table. In general, codes require a mound height between one and four feet. Mound slopes can be up to 25 percent. Mounds should be sited well away from flood plains, drainage ways, or depressions unless flood protection is provided.

Sand suitable for a mound system should contain 20 percent or less material greater than 2.0 mm and 5 percent or less finer than 0.053 mm. Mound design depends on several additional factors, including the number of rooms in a home; up to 150 gallons per day per bedroom are allowed. In addition, to minimize the number of solids entering the mound filter, the septic tank and dosing chamber must be watertight. In Wisconsin, the mound system success rate is more than 95 percent.

A typical mound system in Wisconsin costs approximately \$9,000 to construct, with another \$750 in site evaluation, design, and permitting costs. The operation and maintenance costs range from \$125 to \$200 per year.

3.3.4 TRICKLING FILTER

Trickling filters are effective in removing nitrogen from wastewater. They trickle wastewater over a fixed medium (coarse stones or plastic material) covered with a bacterial mat that removes nitrogen from the effluent. A rotating distributor, which is a rotating pipe containing several holes, evenly distributes the wastewater from above the filter medium. Microorganisms on the medium break down the organic materials in the wastewater as it passes through the medium (see Figure 15).

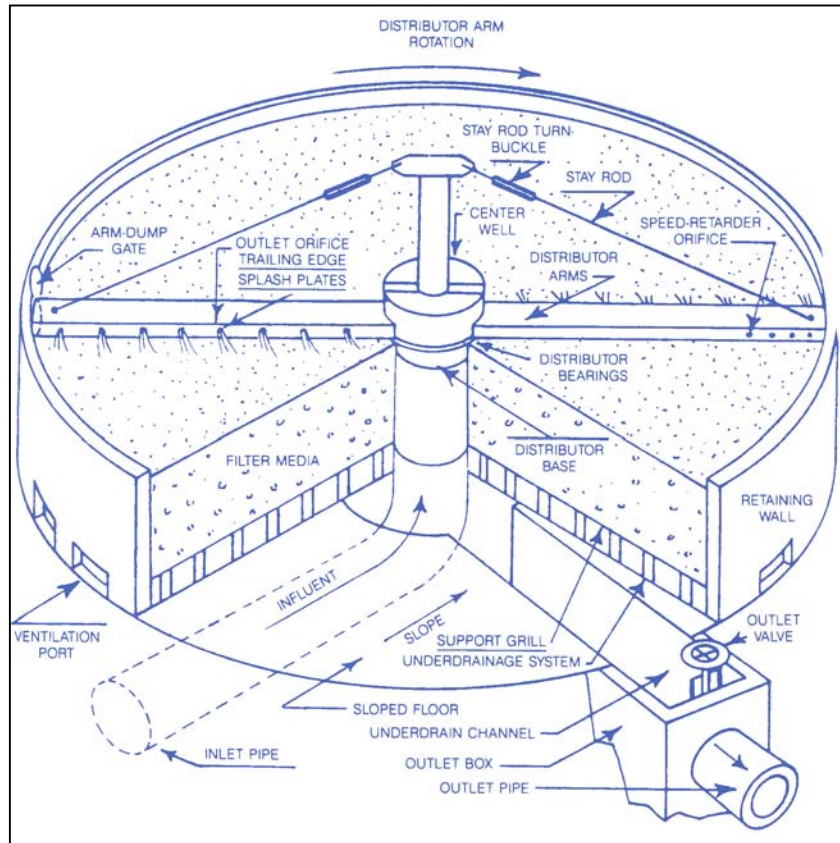

Source: *National Small Flows Clearinghouse Fact Sheet, 1998.*

FIGURE 15. SCHEMATIC OF A TRICKLING FILTER

Trickling filter systems are especially effective when the receiving waterbodies are highly sensitive to nitrogen loading. The filters successfully remove ammonia nitrogen by oxidizing it to nitrate nitrogen. The nitrate nitrogen is then converted into nitrogen gas that is vented to the atmosphere. The filters can accomplish ammonia nitrogen removal in one- or two-stage systems. In a single-stage unit, carbon oxidation (removal of organic material) and nitrification occur in the same unit. In two-stage systems, separate stages operate independently to complete the organic removal and nitrification steps. Trickling filters are highly sensitive to how much oxygen is available and to nitrogen loading rates.

3.3.5 EVAPOTRANSPIRATION

The two primary types of evapotranspiration (ET) systems are the standard ET system and an ET/absorption system (ETA). The more common is the ET system, which comprises a septic tank, an ET sand bed with wastewater distribution piping, a bed liner, fill material, monitoring wells, overflow protection, and a surface cover. Vegetation grows on the cover to facilitate the transpiration process.

Evapotranspiration systems are especially important on sites in need of surface and groundwater protection. An ET system can operate solely as a system that disposes of wastewater into the atmosphere through evaporation from the soil surface and/or transpiration by plants, or it can combine such treatment with seepage.

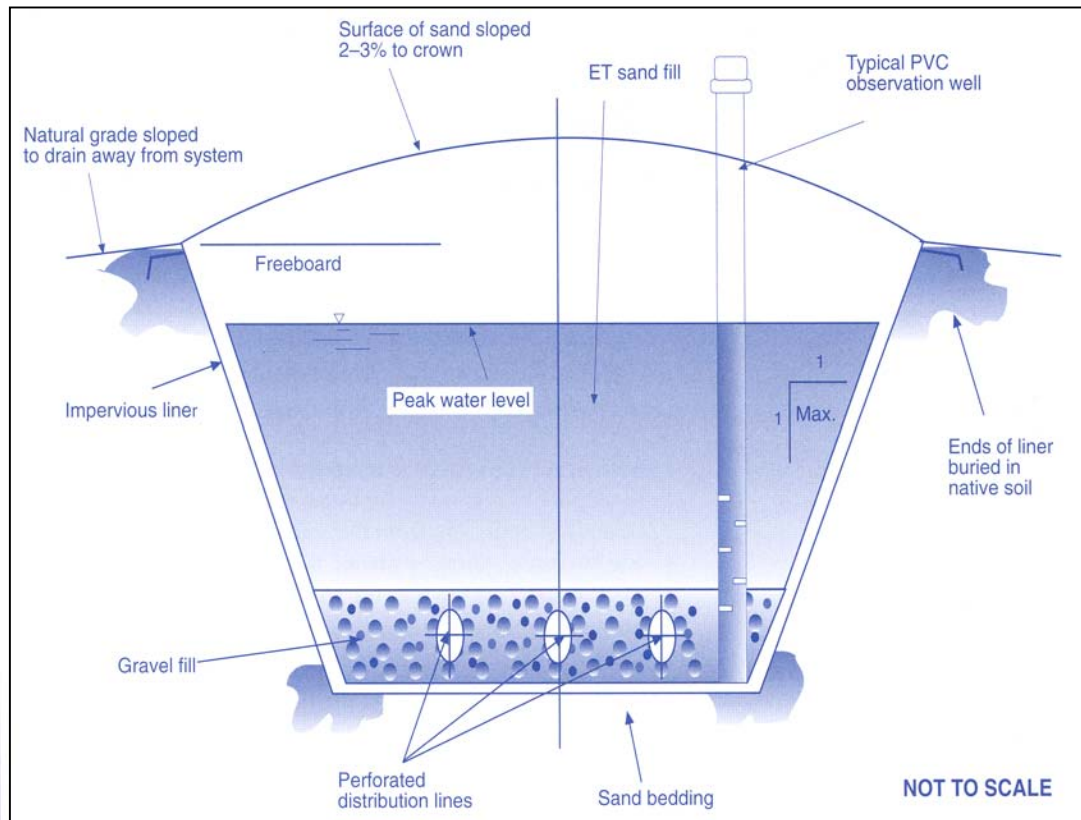

Source: *National Small Flows Clearinghouse Fact Sheet, 1998.*

FIGURE 16. CROSS-SECTION OF A TYPICAL EVAPOTRANSPIRATION BED

In a system that does not seep, the effluent flows from the septic tank into the lower portion of the sealed ET bed, which contains continuous impermeable liners and sand. Capillary action in the fine sand causes the wastewater to rise to the surface and escape into the atmosphere via evaporation. At the same time, vegetation brings wastewater from plant roots to the leaves, where it is transpired. An ET incorporates an unsealed bed, which allows for evaporation, transpiration, and percolation (see Figure 16).

To prevent overloading (with undersized systems) or excessive capital costs (with oversized systems), the design of ET systems requires accurate estimates of wastewater flow rates. The availability of land can limit the size of ET systems: up to 4,000 to 6,000 square feet of area is typically needed for a single-family home. However, the most important factor for ET systems is climate. Precipitation, humidity, wind speed, temperature, and the amount of solar radiation must be important considerations. For instance, system overloading can occur if large amounts of rainfall enter the system over a short period of time. Thus, ET systems are most suitable for use in arid to semi-arid locations such as the western and southwestern parts of the United States. The typical minimum cost for an ET system for a three-bedroom residence is \$10,000.

3.3.6 LOW-PRESSURE PIPE

A low-pressure pipe (LPP) system is a shallow, pressure-dosed soil absorption system with a network of small-diameter perforated pipes placed in narrow trenches (see Figure

17). LPP systems can be used to address septic system issues such as soil clogging from localized overloading, mechanical sealing of the soil trench during construction, anaerobic conditions resulting from continuous saturation, and a high water table.

A typical LPP system consists of a septic tank for primary treatment. Partially treated effluent then flows by gravity to a pumping chamber, where it is stored until it reaches the level of the upper float control. Once the water reaches that level, the pump turns on and usually sends one to two batches of wastewater per day to the trenches via the distribution pipes. During each dosing cycle, the depth of wastewater in the trenches does not exceed two to three inches of the total trench depth.

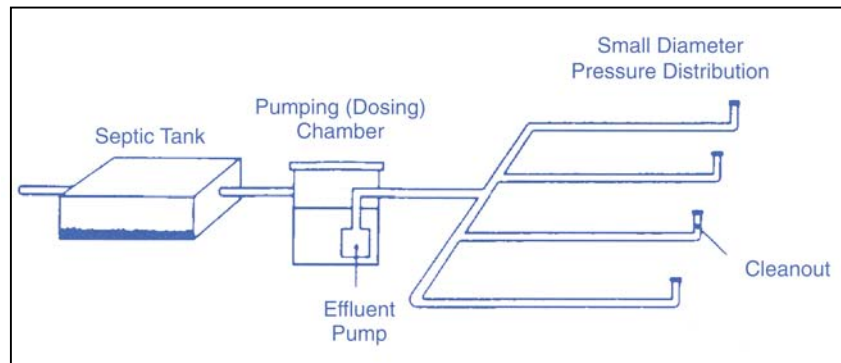

Source: *National Small Flows Clearinghouse Fact Sheet, 1998.*

FIGURE 17. LOW-PRESSURE PIPE SYSTEM

Two critical factors affecting LLP system performance are the dosing and distribution of the effluent. The dosing must be correct to maintain aerobic conditions in the trench, and effluent must be evenly distributed to avoid localized overloading.

A properly designed and installed LPP system needs little maintenance. For instance, North Carolina requires LPP systems to be inspected at least once every six months. The septic tank and pumping chamber should be checked periodically for sludge and scum build-up as needed. Watertight pumping tanks are necessary to ensure that drainfields do not inadvertently become hydraulically overloaded.

In a 1989 study of LPP use in North Carolina, the average cost to install an LPP system for a three-bedroom home was \$2,600. The more LPP systems used in a county, the less is the average cost per system. In counties with several systems, the cost was approximately \$1,500 per system as compared with \$5,000 per system in counties with few LPP systems.

3.3.7 AEROBIC SYSTEMS

Similar to conventional septic systems, aerobic systems also use natural processes to treat wastewater. However, septic treatment does not require oxygen (anaerobic), whereas aerobic treatment does need oxygen. Thus, aerobic units include a device that injects air into and circulates it inside the treatment tank.

According to U.S Environmental Protection Agency, aerobic treatment units can range in size from 400 to 1,500 gallons and usually include an aeration compartment and a settling

chamber. Some units also include a pre-treatment compartment to remove garbage and grease (U.S. Environmental Protection Agency, 2000b). In addition, electrical service is required for the aeration equipment and pumps.

The two types of aerobic systems most often used for single-family homes are fixed-film and suspended-growth systems. Fixed-film systems are not available commercially and, as proprietary devices, are not described in detail here. Suspended-growth systems use microorganisms suspended in the waste stream to break down the wastes.

An aerobic system's application is limited primarily by soil conditions and topography. A site should have a percolation rate of less than 60 minutes per inch, its depth to the water table or bedrock should be two to four feet, and it should have level or slightly sloping topography.

Aerobic systems vary in cost, from \$2,500 to \$9,000 installed. In addition, the units must be maintained more frequently than a septic system. The recommended quarterly servicing costs about \$350 per year.

3.3.8 PROPRIETARY SYSTEMS

Proprietary technologies are designed to provide turnkey solutions to developers' wastewater treatment needs.

Below are brief descriptions of the proprietary systems available today as well as the latest Web sites containing more information on the systems.

- Alascan--<http://www.alascanofmn.com/>

Alascan offers a variety of wastewater treatment options and systems to meet different needs, including source separation systems that separate blackwater from greywater and low-flush toilets that, according to the manufacturer, can reduce a home's water usage by 40 to 80 percent.

- Bio-Microbics, Inc.--<http://www.biomicrobics.com/>

Bio-Microbics, Inc., has created a Fixed Activated Sludge Treatment (FAST®) process. suited for use in single-family dwellings, clustered residential developments, and subdivisions. It can also be used to retrofit a failed conventional septic system.

- Cromaglass-- <http://www.americanpump.com/croma3.htm>

One of the more notable Cromaglass systems is the Cromaglass Batch Treat Process. The manufacturer claims that biological oxygen demand (BOD) and total suspended solid (TSS) removal rates exceed 90 percent and that independent laboratory research verifies system efficacy.

- E/One Sewer Systems--<http://www.eone.com/sewer/intro/index.html>

E/One offers several wastewater treatment systems sized to meet a customer's unique conditions. For instance, the GP 2010 is designed for single-family homes, whereas the GP 2016 is suited for multiple dwellings. The Web site provides brief case studies.

- Global Water Systems-- <http://www.globalwater.com/encampment.htm>

Global's source separation systems treat greywater for reuse in toilet flushing or irrigation.

- MicroSepTec, Inc.--
<http://www.microseptec.com/>

- Blackwater-- Toilet wastes in wastewater
- Greywater--Washwater excluding toilet wastes

The MicroSepTec (MST) system is an on-site wastewater treatment system that can be used for residential applications. In addition, MicroSepTec, Inc., is a full-service septic solution provider and will assist with permits, engineering, project management, maintenance, and monitoring.

- Orenco Systems, Inc.--<http://www.orenco.com/>

Orenco Systems® offers on-site (decentralized) treatment solutions for many types of residential properties for small flows and large flows, household-strength waste and high-strength waste, poor soils, and high groundwater. The company provides a variety of package solutions.

- Waterloo Biofilter Systems, Inc.--<http://www.waterloo-biofilter.com/>

The Waterloo Biofilter® is a patented trickle-filter-type treatment system that uses a filter medium to treat residential and industrial wastewater. Wastewater is sprayed intermittently onto the medium and allowed to drain through by gravity.

3.4 ADDITIONAL RESOURCES

Additional resources with more detail on wastewater treatment are included below. They are not provided as endorsements, merely as educational and reference tools. Given regional variations in climate and land development needs, we have tried to include region-specific resources. It is important to note, however, that addresses, especially Internet links, are subject to change. This list contains the latest links and addresses as of the printing of this publication.

Wastewater Manuals and Best Management Practices

National On-Site Demonstration Program

http://www.nesc.wvu.edu/nodp/nodp_index.htm

The National On-Site Demonstration Program (NODP), established in 1993, was developed to encourage the use of alternative on-site wastewater treatment technologies to protect the public health, ensure water quality, and sustain the environment in small and rural communities. Funded through the U.S. Environmental Protection Agency (EPA) and directed by the National Environmental Services Center of the National Research Center for Coal and Energy at West Virginia University, the NODP provides communities throughout the country with information on cost-effective alternatives to centralized wastewater treatment systems.

U.S. Environmental Protection Agency

<http://www.epa.gov/ORD/NRMRL/Pubs/625R00008/625R00008.htm>

The 2002 *On-site Wastewater Treatment Systems Manual* is the U.S. Environmental Protection Agency's latest publication covering on-site wastewater technologies. As an update of the 1980 *On-Site Wastewater Treatment and Disposal Systems*, it provides supplemental and new information for wastewater treatment professionals in the public and private sectors. This manual is not intended to replace the previous manual but rather to explore further and discuss recent developments in treatment technologies, system design, and long-term system management.

Washington State Department of Ecology

<http://www.ecy.wa.gov/biblio/9911.html>

Washington's *Storm Water Management Manual for Western Washington* describes the storm water management standard for all new development and redevelopment projects in the Puget Sound region.

Organizations and Internet Resources

Canadian Housing Information Center (CHIC)

<http://www.cmhc-schl.gc.ca/publications/en/rh-pr/tech/01-138-E.htm>

Innovative On-Site Wastewater Treatment

The Canadian Housing Information Center has researched problems with residential septic systems across Canada and found surface breakouts, back-ups into houses, and contamination of groundwater supplies as evidence of system failures. Such problems arise from excessive water usage and lack of maintenance; inadequate site assessment, especially in marginal soils; outdated design practices; or poor construction.

http://www.cmhc-schl.gc.ca/en/imquaf/himu/wacon/wacon_001.cfm

Water conservation has been at the forefront of resource efficiency issues in Canada. In an effort to reduce water consumption, CMHC has conducted research into residential water reuse and innovative wastewater treatment technologies. Case Study of the Month presents water projects either supported by CMHC or undertaken by the private sector.

Hazen and Sawyer

http://www.co.sarasota.fl.us/environmental_services/pcssrp/pdfs/40075r048.pdf

Evaluation of On-site Wastewater Treatment and Wastewater Collection System Alternatives (TM No.7)

An assessment of available and applicable OWTS and collection system technologies determines the technologies' ability to improve current wastewater treatment and disposal practices in the Sarasota, Florida area.

NAHB Research Center

<http://www.toolbase.org/tertiaryT.asp?TrackID=&DocumentID=3789&CategoryID=1843>

On-site wastewater treatment systems can allow the construction of new homes on otherwise vacant infill lots in neighborhoods whose centralized wastewater treatment systems are beyond capacity. To find the best and most cost-effective aerobic treatment system, the Research Center is working with Anne Arundel County, Maryland, and will monitor the installation of several innovative on-site aerobic wastewater treatment systems on residential field sites. Approximately 25 percent of all homes in the county use on-site wastewater treatment systems, most of which are septic tanks.

Rocky Mountain Institute

<http://www.rmi.org/images/other/W-ComDecMakWstwtrSys.pdf>

Case Studies of Economic Analysis and Community Decision Making for Decentralized Wastewater Systems

The Rocky Mountain Institute is conducting an 18-month project to increase understanding of how communities consider and value the benefits and costs of different-scale wastewater facility options (on-site, cluster, and centralized options) in dollar or other terms. The project also is examining the driving issues, motivations, thought processes, and decision-making methods of stakeholders relative to choices of wastewater system scale.

Small Flows Quarterly

http://www.nesc.wvu.edu/nsfc/nsfc_index.htm

The National Small Flows Clearinghouse (NSFC), funded by the U.S. Environmental Protection Agency, helps America's small communities and homeowners solve their wastewater problems and thereby protect the public health and the environment. The successful long-term operation of wastewater systems protects drinking water sources from contaminants and natural systems from pollutants. The NSFC assists in planning, operating, financing, and managing new or existing sewage systems, both for individual households and communities of less than 10,000 people. One of the *Small Flows Quarterly's* most recent peer-reviewed articles, "Proposed National On-Site Standards: A Broad Assessment of Their Relative Benefits to Industry," proposes ideas about on-site wastewater treatment management in small communities. In most states, regulatory systems dominated by prescriptive codes restrict the activities of on-site wastewater treatment system manufacturers and suppliers.

The Home Inspection and Construction Information Website

<http://www.inspect-ny.com/septic/lockwood.htm>

Septic Systems--An Engineer's View

The Home Inspection and Construction Information Web site describes septic systems, their operation, and the reasons for system failure. Contributed by Lockwood, Dietershagen Associates Licensed Professional Engineers, Clifton Park, New York.

U.S. Environmental Protection Agency

<http://www.epa.gov/OW/index.html>

The Office of Water provides an immense amount of information on the protection and conservation of our nation's water resources.

Regional-Specific Resources

Northeastern United States

Cornell Local Government Program

http://www.cardi.cornell.edu/clgp/septics/Exec_Summ.PDF

Increasingly, rural communities, unsewered subdivisions, and responsible agencies are aware of issues and concerns associated with treating and managing human waste products with on-site wastewater treatment systems (OWTSs or septic systems). This guide provides an information framework for those seeking change.

The New England Interstate Water Pollution Control Commission Regulatory Cooperation Project

<http://www.neiwpcc.org/iatech.html>

An interstate effort to evaluate innovative/alternative (I/A) on-site technologies capable of protecting the public health and the environment. The project provides states with an efficient review process for I/A technologies. By bringing together the interests of regulators and end users, the effort facilitates independent evaluation of environmental technology performance.

Southeastern United States

Commonwealth of Virginia State Board of Health

<http://www.vdh.state.va.us/formfeed/VDH88.PDF>

Regulations Governing Application Fees for Construction Permits for On-Site Sewage Disposal Systems and Private Wells

Western United States

City of Oregon City--Development Services Department Engineering Division

<http://www.orcity.org/public-works/design-standards/sewer/index.html>

Sanitary Sewer Design Standards

Oregon City Development Services (Oregon) created sewer design standards to provide a consistent policy under which certain physical aspects of sanitary sewer design will be implemented.

Orenco Systems Incorporated

http://www.orengo.com/ccs/ccs_caseStudy.asp

Orenco Case Study--Diamond Lake, Washington: 12-Year-Old Effluent Sewer Requires Little Maintenance

The community of Diamond Lake, in northeast Washington, protected an 800-acre lake by replacing all the community's old, leaking septic tanks and inadequate disposal systems with watertight tanks and an Orenco effluent sewer system.

SECTION 4: CIRCULATION AND DESIGN



Reconsidering traditional methods for planning and accommodating pedestrian and vehicular circulation is part of a cadre of better site design techniques that can simultaneously reduce development costs, protect the environment, and create win-win situations for builders, municipalities, and residents.

4.1 INTRODUCTION

As the struggle to decrease nonpoint source pollution in our nation's waters continues, municipalities have begun to reexamine the connection between circulation design and storm water management practices. New designs for streets, sidewalks, and driveways can maintain the functions of circulation while helping to reduce expanses of impervious surfaces that can alter local hydrology and degrade water quality. In turn, new street designs can influence the layout of lots and help to increase the volume of open space in new residential developments. These considerations all contribute to creating low impact developments. This section examines alternative street and lot layouts and their associated environmental and cost benefits.

Vehicular and pedestrian circulation systems have always played an important role in organizing and defining residential communities. Traditionally, residential or local streets have been designed with a focus on accommodating community access, circulation, and parking. In the years before World War II, older, close-in suburban neighborhoods were designed with narrow streets that were wide enough for one travel lane and parking on one side of the street.

In the years after World War II, suburbanization and highway construction grew at a rapid pace. As reliance on the automobile increased, transportation planners identified the need for a hierarchy of safe and efficient transportation routes linking suburban residences with urban employment centers, retail concentrations, and recreation opportunities. They developed a hierarchy of highways, arterials, collectors, and local streets. The classification system sought to strike a balance between providing mobility and access.

- **Mobility**--A measure of long-distance travel at relatively higher speeds. Mobility usually characterizes highways.
- **Access**--A measure of service to origins and destinations. Access usually relates to local streets.

Unfortunately, at some point during post-war suburban expansion, the classes within the hierarchy blurred. Communities started to design local streets according to standards more appropriate to arterial road and highway construction. Many areas of the country saw pavement widths widened to accommodate increased vehicle trips, ensure access for larger emergency vehicles, and provide parking spaces on both sides of the street (even though most neighborhoods accommodate off-street parking in driveways). The larger impervious areas created by wide streets have led to increased storm water runoff, reduced water quality, and riparian habitat and species degradation. They have also translated into increased design, construction, and maintenance costs for both developers and municipalities. Low impact development practices can help to alleviate these concerns.

What is the cost of an excessively wide street?		
<p>Not only do excessive street widths affect the livability of a community, but they also give rise to additional costs that must be paid by homeowners. The figures cited here are for 2001 based on unit costs of contractor services for a project in northern California. For this project, a section of street 100 feet long would cost about \$9,500 to build to a width of 24 feet compared with \$13,500 for a 36-foot-wide street. Paving widths are 20 feet and 32 feet, respectively, with an additional two-foot gutter on each side. Moreover, in this area where lots sell for \$300,00 per acre, land costs exceed street construction costs, even for narrower streets. Total land and construction costs for a 100-foot section of a 36-foot-wide street amount to almost \$40,000 compared with \$26,000 for a narrower 24-foot-wide street.</p>		
Cost per 100 Feet of Street		
	24 Feet	36 Feet
5-Inch Asphalt Paving/6-Inch Base	\$6,800	\$10,880
6-Inch Curb and Gutter	\$1,265	\$1,265
4-Inch Sidewalk	\$1,400	\$1,400
Total Construction Costs	\$9,465	\$13,545
Land (at \$300,000 per acre)	\$16,800	\$25,200
Total Cost	\$26,265	\$38,745

TABLE 17. TYPICAL STREET CONSTRUCTION COSTS

This chapter begins by providing a brief overview of the environmental and economic benefits of LID circulation and design. It briefly discusses conventional approaches to circulation and design and then concludes by considering some alternatives to conventional approaches. Table 18 provides some overall objectives of community circulation and design systems.

<p>Objective 1: Maximize open space by using alternative street and lot layouts.</p> <p>Objective 2: Reduce impervious surfaces by considering alternative street widths, types, and amenities.</p> <p>Objective 3: Site lots and houses to maximize solar orientation, reduce vehicular trips, and create a sense of community.</p>
--

TABLE 18. CIRCULATION AND DESIGN OBJECTIVES

4.1.1 ENVIRONMENTAL BENEFITS

Properly designed and sited streets and street systems can conserve and protect site and regional environmental systems and resources. Most street standards are the result of compromises among engineers, planning staffs, and local emergency management professionals (police and fire and rescue services). To provide two travel lanes, access for emergency vehicles, and parking on both sides of the street, communities have long required streets that are much wider than necessary. However, research and experience show that compact street layouts, narrower street widths, and alternative pavement edge treatments can minimize clearing and grading, reduce storm water runoff, and protect

water quality while providing ample access for emergency vehicles, residential vehicles, and parking.

Paved streets create impervious surfaces that prevent storm water from infiltrating into the ground. As storm water travels across streets and other impervious areas, it picks up motor oils, grease, fuel residues, nutrients, and sediment, all of which are then carried to local receiving waterbodies where they adversely affect aquatic species and their habitats. Impervious areas are major contributors to the urban nonpoint source pollution problems that impair the nation’s water quality.

4.1.2 ECONOMIC BENEFITS

Where density and zoning allow, redesigned vehicular and pedestrian circulation routes can reduce final infrastructure and development costs by limiting street lengths and the expanse of pavement. At the same time, reworked street types and layouts can mean reduced costs associated with planning and design, clearing and grading, and storm water management. Table 4-3 provides information on various subdivision development costs.

Subdivision Improvement	Unit Cost
Roads, Grading	\$22.00 per linear foot
Roads, Paving (26-foot width)	\$71.50 per linear foot
Roads, Curb and Gutter	\$12.50 per linear foot
Total Cost of Road	\$106.00 per linear foot
Sidewalks	\$10.00 per linear foot
Storm Sewer (24 inches)	\$23.50 per linear foot
Driveway Aprons	\$500 per apron
Parking Spaces	\$1,100 per parking space (\$2.75 per square foot)
Clearing (forest)	\$4,000 per acre
Sediment Control	\$800 per acre
Storm water Management	\$5,000 to \$60,000 per impervious acre
Water/Sewer	\$5,000 per lot (variable)
Well/Septic	\$5,000 per lot (variable)

Source: Center for Watershed Protection, 1998.

TABLE 19. UNIT COST ESTIMATES OF TYPICAL SUBDIVISION DEVELOPMENT

4.2 CONVENTIONAL APPROACHES TO CIRCULATION AND DESIGN

4.2.1 RIGHTS-OF-WAY

A street right-of-way is a measure of the total width needed to accommodate the street pavement, sidewalk(s), drainage, street trees, and utility easements. Current street rights-of-way range from 30 feet to over of 60 feet to accommodate parking and sidewalks on both sides of the street. Excessive rights-of-way create wide and often visually uninteresting streets that promote speeding and undermine safety. Wider street rights-of-

way require land to be set aside to accommodate street systems, leaving less land available for lots and community open space. At the same time, given that safety and maintenance concerns require the removal of vegetation and trees within the right-of-way, road construction results in the removal of many mature trees and vegetation, potentially leading to soil erosion and siltation problems in local waterways.

Street rights-of-way should be the minimum width necessary to accommodate the pavement, sidewalk(s), street trees, and utilities. Where zoning and density allow, communities should permit open-section roadways with sidewalks on one side of the roadway only. Open-section roadways consist of a variable-width gravel shoulder, usually wide enough to accommodate a parked car, and an adjoining grassed swale that conveys storm water. Street pavements should be adjusted accordingly depending on off-street parking availability and shoulder requirements. To encourage the preservation of existing vegetation, only those trees within approximately five feet of the pavement edge should be cleared. Utilities should be located under street pavements to eliminate conflicts with tree roots, grassed swales, and bioretention areas. In northern climates, the right-of-way should be wide enough to accommodate snow storage.

4.2.2 STREETS

Besides rooftops and driveways, residential streets account for an enormous share of a community’s impervious surfaces. A reevaluation of residential street standards to address the expanse of impervious surfaces and enhance the environment can also reduce infrastructure costs, improve pedestrian and vehicular safety, and increase community aesthetics. Many municipalities have already begun the difficult process of reevaluating their residential street standards. The process requires the involvement of many different stakeholders, including emergency personnel (police and fire and rescue services)(See Table 20), public works departments, school boards, homeowner associations, and safety advocates. Indeed, disagreements can be easily resolved by examining the current research on the use of narrower streets.

Width (feet)	Source
18 to 20	U.S. Fire Administration
24 (on-street parking) 16 (no on-street parking)	Baltimore County, Maryland
18 (minimum)	Virginia State Fire Marshal
20	Prince George’s County, Maryland
18 (on-street parking on one side) 26 (parking both sides)	Portland, Oregon

Source: Center for Watershed Protection, 1998.

TABLE 20. MINIMUM STREET WIDTHS FOR FIRE VEHICLES

Most municipalities’ standards for street pavement widths usually specify streets at least 36 feet wide—a width that usually accommodates two travel lanes and parking on both sides of the street (see Table 21). Given that most homes are built with either garages and/or driveways that accommodate up to three cars, municipalities should consider eliminating one or both of a street’s seven-foot-wide parking lanes. Even a new street width of 22 feet can still accommodate parking on one side of the roadway and leave

ample room for a safe travel lane that is generous enough to accommodate most fire trucks, school buses, and garbage trucks. Consistent with low impact development practices, the new standards reduce infrastructure construction and maintenance costs while reducing impervious surfaces within the community (See Section 4.3.2 on queuing streets for additional information).

Local Streets	
No On-Street Parking	18 feet
Parking on One Side	22 to 24 feet
Parking on Both Sides	24 to 26 feet
Collector Streets	
	32 to 36 feet

Source: Residential Streets, NAHB, 2001.

TABLE 21. SUGGESTED PAVEMENT WIDTHS

Where density and zoning allow, open-section roadways can reduce the need for costly curb and gutter sections and encourage the filtering and infiltration of storm water. Open-section roadways consist of a variable-width gravel shoulder, usually wide enough to accommodate a parked car, and an adjoining grassed swale that conveys storm water. The grassed swales are usually pitched at a minimum of 1 percent to prevent standing water and end at a drop-inlet storm structure or waterbody. Historically, improperly designed swales posed health concerns because they served as breeding areas for insects and caused flooding. However, if communities follow current engineering standards for the design of swales, they no longer have to concern themselves with the associated health and flooding issues (see Section 2.3.3.1 for additional information on grassed swales).

4.2.3 INTERSECTIONS

A curb radius is the radius of the circle formed by the curve of the curb at the intersection corners.

Intersections create large areas of impervious surface within residential subdivisions. Reducing the overall size and width of intersections can decrease the volume of storm water runoff. Depending on the class of street entering the intersection, the number of travel lanes, and the dimensions of the curb radii, intersection diameters can become overly wide. The larger the curb radii, the larger the intersection. Recommended ranges for curb radii are contained in Table 22. Smaller, tighter radii can slow turning traffic and make the intersection safer for pedestrians while limiting the expanse of impervious surface.

Type of Intersections	Curb Radius (in feet)
Local/Local	10 to 15
Local/Collector	15 to 20
Collector/Collector	15 to 25

Source: AASHTO.

TABLE 22: RECOMMENDED RANGES FOR CURB RADII

One of the best ways to reduce the impacts of impervious areas within intersections is to incorporate a traffic circle into the middle of the intersection. A traffic circle in the center of an intersection serves a variety of functions. First, it can slow traffic through the intersection and community, making the area safer for pedestrians and vehicles. Second, storm water generated by the impervious areas of the intersection can be routed to a bioretention area sited in the center of the traffic circle where it is detained and treated. Finally, traffic circles can add character to a neighborhood and create visual interest along the streetscape.

Traffic circles are usually smaller than their counterparts, the traffic roundabout. While traffic circles are more appropriate for lower-speed, smaller-volume residential intersections, roundabouts are better suited for collector streets that serve higher traffic volumes. Generally, traffic circles are 15 to 20 feet in diameter and require no additional street space than standard intersections. The center can be planted with a variety of native plants that are well suited for harsher street conditions and whose root structures will tolerate periodic inundation with water and provide superior nutrient uptake.

4.2.4 CUL-DE-SACS

Cul-de-sacs are dead-end streets that terminate in bulb-shaped paved areas, with lots cited around the perimeter of the street (see Figure 18). Given homebuyer preferences for residential cul-de-sac properties, many developers try to incorporate as many cul-de-sacs as possible into new developments. Depending on a subdivision's lot size and street frontage requirements, five to ten houses can usually be located around a standard cul-de-sac perimeter. The bulb shape allows vehicles up to a certain turning radius to navigate the circle. To allow emergency vehicles to turn around, cul-de-sac radii can vary from as narrow as 30 feet to upwards of 60 feet, with right-of-way widths usually extending ten feet beyond these lengths.

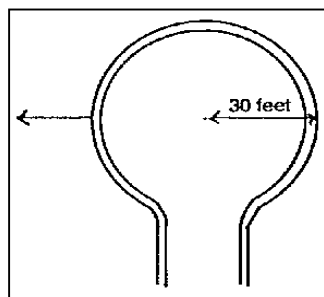

FIGURE 18. STANDARD CUL-DE-SAC

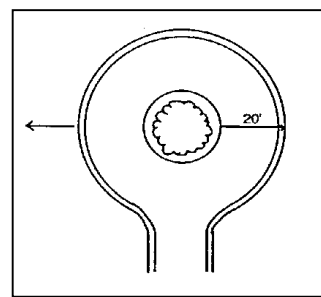

FIGURE 19. STANDARD BIORETENTION CUL-DE-SAC

Unfortunately, cul-de-sacs create excessive amounts of pavement that generate large volumes of storm water runoff. However, to reduce the expanse of paved surface and treat the runoff from the remaining pavement, cul-de-sacs can be designed with center vegetated islands (see Figure 19). As with intersections, the islands can be constructed as bioretention areas that detain storm water and filter urban pollutants such as grease, oils, hydrocarbons, and nutrients. For safety reasons, bioretention areas should be designed with underdrain and emergency overflow systems that safely convey peak flows into conventional storm drains.

Cul-de-sac designs with center bioretention islands should, at a minimum, retain 18-foot pavement widths around the island. To accommodate emergency vehicles, school buses, and sport utility vehicles, the portion of the travel way at the top of the island, which is directly opposite the entry, may be widened by several feet. Curb aprons can replace curb and gutter systems for the islands and allow water from the street to enter the system easily.

For dead-end streets serving fewer than ten houses, another option for reducing the expanse of impervious surface is "T-" or "Y-"turnarounds or auto courts (see Figure 20). These designs function much as cul-de-sacs but, due to a reduction in the area of paved surface, cannot accommodate bioretention areas in their centers. However, given that a standard 60-foot by 20-foot T- or Y-turnaround yields a paved area only 43 percent as large as the smallest (30-foot radius) circular turnaround, the turnaround generates much less storm water runoff (National Association of Home Builders, 2001) than that associated with traditional cul-de-sacs. Runoff could even undergo treatment in curbside swales located within the right-of-way.

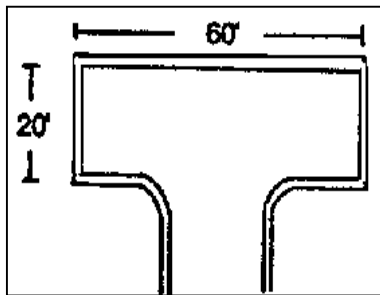

FIGURE 20. STANDARD "T-"TURNAROUND

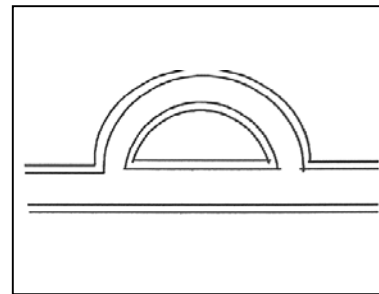

FIGURE 21. STANDARD LOOP TURNAROUND

An auto court is a functional automobile and pedestrian area that is surrounded by a cluster of homes and usually paved with decorative brick or stone pavers. Individual shortened driveways or garages are located immediately off the court. Auto courts use permeable paving systems, allowing runoff to percolate into and undergo filtration by the subsoil underlying the pavers. The systems help recharge local groundwater tables and reduce the need for conventional storm water management improvements. It should be noted, however, that the labor and material costs associated with the individually placed pavers exceed the cost of conventional asphalt paving. Costs may also be incurred for regular maintenance to remove any sediment and silt that accumulate in spaces between the pavers.

Looped turnarounds (see Figure 21) are another option for providing access to a small number of lots while limiting the expanse of impervious surface. Looped roads offer the same private and emergency vehicle access as standard cul-de-sacs, but without the added asphalt and construction costs. Similar to cul-de-sacs with center bioretention areas, the pavement width on a loop road should be no less than 18 feet to accommodate buses, emergency vehicles, and sport utility vehicles.

4.2.5 PARKING

No other decision can affect the final width of streets and ultimately the generation of storm water runoff as much as parking requirements. Most local ordinances require at

least 2 to 2.5 parking spaces per residence, either accommodated in a garage, in a driveway, or on the street. Current residential street standards tend to accommodate street parking on both sides of the street when in fact, the houses served by the street usually provide ample parking either in a driveway or garage. Most on-street parking spaces are 8 feet by 20 feet, resulting in long, underused street sections outside the general path of travel and excessively wide streets that are both expensive to construct and generate considerable quantities of storm water runoff. It is estimated that each seven- to eight-foot on-street parking lane can increase a street's impervious cover by 25 percent (Sykes, 1989). Given that most municipalities require post-development stormflows not to exceed pre-development flows, compliance with parking standards can translate into added costs for storm inlets, piping, and detention basin sizing.

From a water quality standpoint, water temperature can increase as storm water runoff moves across heated asphalt. As elevated-temperature water flows to a waterbody, it can damage sensitive aquatic environments, especially cold-water fisheries. The reduction of on-street parking, however, allows for narrower streets that can take advantage of the cooling effects of shade trees.

4.3 ALTERNATIVE APPROACHES TO CIRCULATION AND DESIGN

4.3.1 ALTERNATIVE DESIGN CONSIDERATIONS

Just as alternative street types and pavements can reduce infrastructure costs and environmental impacts, so, too, can alternative residential street layouts. When coupled with narrower, open-section streets, a well-designed street layout can eliminate hundreds of square feet of impervious surface. Depending on the density, location, and type of subdivision, different types of street layouts may easily lend themselves to a cluster arrangement, conserving natural features, maintaining open space, and protecting water quality.

Rethinking traditional circulation designs within residential subdivisions can result in:

- Decreased storm water quantities and nonpoint source pollution;
- Increased groundwater recharge; and
- Increases in community open space.

Traditional grid, curvilinear, and hybrid street patterns each have different characteristics that affect traffic movement, environmental values, and community aesthetics (see Figure 22). Grid patterns are typical of older, densely settled urban areas and are particularly effective in expediting traffic flow. Yet, research has indicated that they require 20 to 25 percent greater total street length than traditional, suburban curvilinear patterns and are most appropriate for flat sites with several access points. Given that densities in grid areas are often high, parking is generally needed on at least one side of the street.

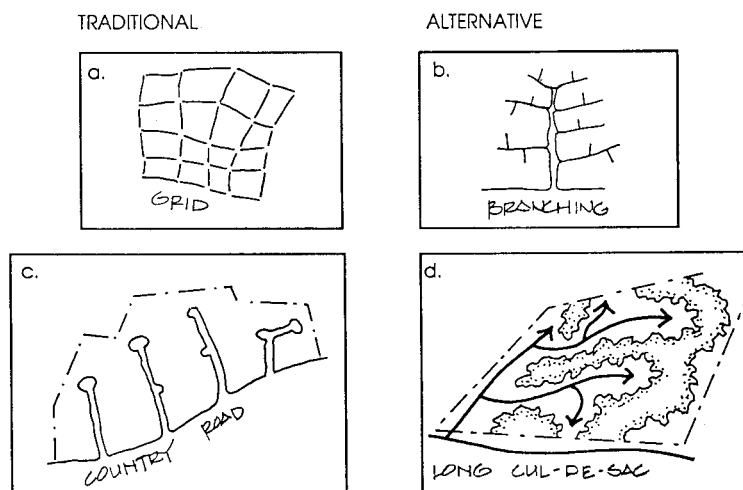

FIGURE 22. STREET LAYOUT EXAMPLES

Curvilinear patterns are best suited for larger-lot communities or communities with undulating topography. They are most popular in suburban settings and usually maximize the use of long cul-de-sacs that concentrate clusters of houses around natural resource areas, such as waterbodies. While the use of longer, winding streets and cul-de-sacs translates into greater expanses of impervious surface, communities can narrow their streets by limiting parking to only on one side of the street.

Possibly the best choice for suburban systems are hybrid layouts. Hybrid systems provide a balance between conventional grid and curvilinear patterns and are well suited to developments characterized by a mix of housing types and styles. They also permit the creation of open space. Hybrid systems can minimize the need for clearing and grading and help protect forests, wetlands, and trees.

Traffic Calming

Traffic calming refers to a set of measures designed to mitigate the effects of unmanaged traffic on urban and suburban roadways. While the use of traffic calming as a traffic mitigation strategy is beyond the scope of this publication, the practice is discussed here in terms of its relationship to low impact development and storm water management.

Certain traffic-calming measures, such as roundabouts or traffic islands, can be designed as vegetated bioretention islands that retain and treat street runoff. A traffic roundabout is a circle centered in an intersection; it slows traffic entering the intersection and directs it to exit points around the circle. Usually, a roundabout is raised and includes curbs and areas planted with grass or vegetation. Where street grades allow, roundabouts can be converted into bioretention areas.

Bioretention areas can be bordered by either curb cuts or flush-mount curbs that allow water to exit an intersection efficiently and enter the treatment system. Either treatment method allows for a transition between the street pavement and vegetated and mulched areas. As storm water enters the system, specially selected vegetation and engineered

soils retain and treat it. For reasons of safety, roundabouts designed for bioretention should incorporate underdrains and/or emergency overflow areas to prevent excessive ponding or flooding.

Clustering

With respect to lot layout, developers can turn to methods such as clustering to preserve open space, reduce infrastructure costs, and accommodate growth. This strategy concentrates small pockets of homes around the site in the least environmentally sensitive areas. In a clustered community, homes may be built on lots as small as 8,000 square feet, allowing developers to preserve unique land forms, trees, and vistas. Developers may need to work with local zoning officials to allow the use of clustering, if current zoning ordinances do not allow it. In addition, potential homeowners may need to be persuaded that cluster development creates a community that offers ample amounts of open space within walking distance of their homes.

More than half of the 1,350 real estate agents surveyed by Bank of America thought that trees have a positive impact on potential buyers' impressions of homes and neighborhoods. In addition, 84 percent of agents indicated that a home with trees would be as much as 20 percent more salable than a home without trees.

Source: Building Greener Neighborhoods.

Tree-Save Areas

Many parcels of land offer an array of natural resources that ingenious developers can capitalize on and transform into desirable design features. While most of this section of the publication has focused on ways to protect the water supply and thus enhance the environment, trees are a feature that homeowners value for their aesthetic and environmental benefits. Trees can shade homes, streets, parking areas, sidewalks, and paths, adding to the visual appeal of communities and helping to reduce heat island effects. Developers are beginning to recognize that lots with mature trees often sell for more than comparable lots without such trees.

Native trees should be identified during a project's planning stage. The Building *With* Trees (BWT) program offers more details on how best to preserve appropriate trees. The National Arbor Day Foundation, with support from the National Association of Home Builders, created the BWT program to help developers streamline the process of saving natural resources during land development. Program details can be found at <http://www.arborday.org/programs/buildingwithtrees/>

Solar Orientation

In an effort to maximize energy efficiency for homeowners, some developers are building resource-efficient communities by orienting streets and lots to take advantage of passive solar design. Passive solar design optimally uses the sun's energy for heating and cooling. During the design process, builders aim to orient as many lots as possible to take advantage of solar benefits. The optimum position for maximum passive solar orientation is to orient the façade of the house directly south, however, the axis can vary within 20 degrees of true south with minimal detrimental effect on solar gain. Streets should be oriented on an east-west axis.

4.3.2 ALTERNATIVE STREET TYPES

To meet the multiple and sometimes competing goals of creating affordable, environmentally friendly, and aesthetically pleasing communities, developers are incorporating alternative street designs into their plans. Each alternative street and path type has unique characteristics that help it fit into one part of the community, but not the other. One street type does not fit all situations.

Queuing Streets

Queuing streets are narrower street types that contain one parallel parking lane and a travel lane sufficiently wide to accommodate the passage of larger emergency and service vehicles. In instances where cars park along the roadway, queuing streets require one car to wait temporarily in “queue” until the oncoming car passes (see Figure 23). Traditionally used in older, closer-in suburban neighborhoods, queuing streets are enjoying a renaissance

Prairie Crossing, a development near Chicago, focused on creating a community that embraces environmental protection, a sense of place, and resource conservation. Sales for Prairie Crossing homes are at a 40 percent premium over comparable homes nearby.

Typically, queuing streets range between 20 and 26 feet wide, with a 12- to 13-foot travel lane and a seven-foot parallel parking lane. Compared to a typical 36-foot-wide street, queuing streets can reduce planning and design costs as well as other infrastructure costs, such as those associated with storm water management. It has been estimated that the elimination of parking on one side of the street can reduce storm water runoff by 25 percent (Center for Watershed Protection, 1998).

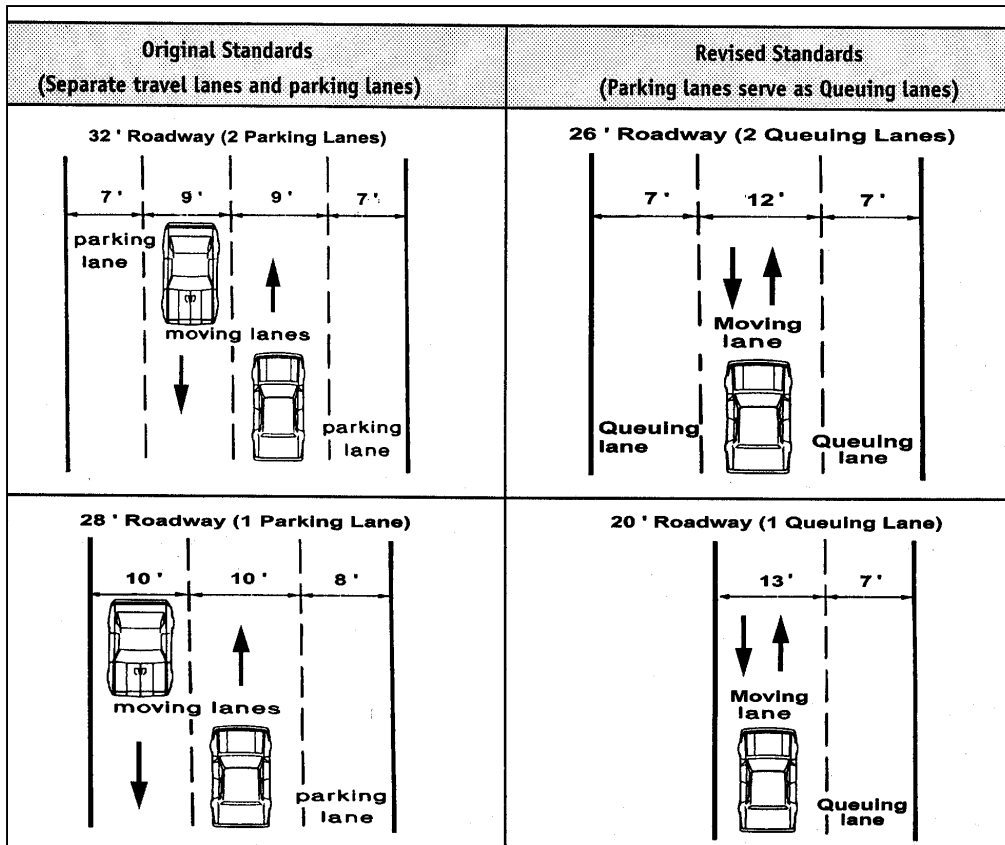

Source: Portland (OR) Office of Transportation, 1994.

FIGURE 23. A COMPARISON OF QUEUING STREETS VERSUS TRADITIONAL STREETS

From an environmental standpoint, narrower street rights-of-way can limit the amount of land areas subject to clearing and grading, make more land available for open space, and protect natural resource areas. Smaller streets also provide safer environments for pedestrians, which encourages walking and reduces dependence on the automobile.

Alleys

Alleys are considered a neotraditional design element that can be incorporated into residential designs to provide garage access and parking while accommodating functions such as utility maintenance and refuse collection. Alleys can also alleviate the need for on-street parking, which can increase street widths and the expanse of impervious surface. To limit the expanse of impervious surface, alleys should be no wider than 12 feet and constructed without curbs. An inverted crown that channels water to the center of the alley and then to either a storm drain or bioretention area can accommodate drainage.

Open-Section Streets

Instead of sending storm water to curbs and gutters, open-section roads drain storm water into grassed swales, where vegetation and soils treat pollutants. It has been estimated that, compared with any other residential design feature, streets contribute the highest volume of pollutants to urban storm water (Bannerman et al., 1993). Accordingly, where

density and traffic flow allow, streets with curb and gutter sections should be designed as open-section roadways.

For public works departments in most communities, maintenance concerns dictate a preference for curb and gutter roads in place of grassed swales. Grassed swales are more likely to be damaged by cars, erosion, and so forth while curb and gutter streets are easier to clean and provide a clear transition between pavement and lawn. However, in many localities, curbs and gutters drain directly to streams, lakes, and rivers, where they deposit harmful urban pollutants.

Open-section streets are less expensive to construct than curb and gutter systems. One study for a project in northern California in 2001 suggested that each linear foot of six-inch curb and gutter added approximately \$12.65 to street construction costs (NAHB Residential Streets, 2001).

4.3.3 SHARED DRIVEWAYS

Shared driveways, sometimes referred to as pipestems, are another design tool that can help reduce the expanse of impervious surfaces. Driveways account for as much as 20 percent of the impervious cover in a residential subdivision (Center for Watershed Protection, 1995). Similar to a cul-de-sac, a shared driveway provides access to several houses from a single egress point off the local street. However, unlike cul-de-sacs, shared driveways terminate at the last house served instead of at a large impervious turnaround area. Table 23 provides several objectives for reducing impervious areas in driveways.

- | |
|---|
| <ul style="list-style-type: none">• Shorten driveway length through reduced front yard setback requirements.• Reduce driveway widths or encourage driveway sharing between two or more homes.• Use permeable pavements or a two-track surface with grass in between to facilitate water infiltration. |
|---|

TABLE 23. DRIVEWAY CONSIDERATIONS FOR REDUCING IMPERVIOUS AREA

Where used in the appropriate situation and correctly designed, shared driveways can be functional, attractive, and environmentally friendly. In fact, alternative pavement materials such as bricks or pavers can further reduce a shared driveway's storm water runoff.

4.3.4 SIDEWALKS AND PATHS

While sidewalks and paths are an integral part of a community's transportation and circulation design, their impervious surface nonetheless contributes to the community's overall volume of storm water runoff (see Table 24). Depending on the density of the community and the type of street classification, sidewalks on only one side of the street might be appropriate; in the case of rural residential streets (250 average daily trips, sidewalks might not be needed at all. In rural residential instances, rights-of-way with a sufficiently wide gravel path can accommodate pedestrian and bicycle travel. Where used in combination with open-section roadways, sidewalks should be located several feet back from the outside crest of the grassed swale to allow for maintenance of the

swale and snow storage. Sidewalks should be horizontally sloped to drain toward roadside grassed swales and away from front yards.

- Shorten sidewalk length from the house to the street by reducing front yard setback requirements.
- Maximize sidewalk widths at four feet, depending on density.
- Increase the distance between the street and sidewalk to increase the likelihood that the grassy strip will be able to capture and absorb sheetflow from the sidewalk. Similarly, grade the sidewalk such that runoff drains toward the front yard and not the street.
- Place sidewalks in areas with pedestrian traffic.

TABLE 24. SIDEWALK CONSIDERATIONS FOR IMPERVIOUS AREAS

To reduce further the total expanse of a site’s impervious surface, the use of pervious materials for sidewalks and paths might be considered in place of traditional concrete or asphalt. When properly maintained, alternative materials such as brick, compacted stone dust, and wood chips all accommodate safe passage of pedestrians and bicycles and, in most cases, still meet Americans with Disabilities Act (ADA) requirements. Permeable materials reduce the volume of slow runoff, allowing it to recharge groundwater.

4.3.5 ALTERNATIVE PAVEMENTS

Alternative pavements for streets, alleys, sidewalks, paths, and driveways should be considered along with traditional asphalt and concrete. Brick, block, concrete, and stone pavers reduce the percentage of site’s impervious surface as well as the demand for conventional storm water management facilities. Unlike conventional pavements, pavers encourage groundwater recharge and reduce the runoff of pollutants such as oil, grease, hydrocarbons, and nutrients. A variety of alternative pavements can also meet different traffic, regulatory, climatologic, and aesthetic concerns. In addition to their environmental benefits, alternative pavements such as brick can add visual appeal and character to residential properties.

Material	Initial Cost	Maintenance Cost	Water Quality Benefits
Asphalt/Concrete	Medium	Low	Low
Pervious Concrete	High	High	High
Porous Asphalt	High	High	High
Turf Block	Medium	High	High
Brick	High	Medium	Medium
Natural Stone	High	Medium	Medium
Concrete Unit Paver	Medium	Medium	Medium
Gravel	Low	Medium	High
Wood Mulch	Low	Medium	High
Cobbles	Low	Medium	Medium

Source: Bay Area Storm Water Management Agencies Association (BASMAA), Start at the Source: Residential Site Planning & Design Guidance Manual for Storm Water Quality Protection, 1997.

TABLE 25. FUNCTIONAL COMPARISON OF VARIOUS TYPES OF ALTERNATIVE PAVEMENTS

Compared with conventional paving systems, material and installation costs can be higher for alternative paving systems (see Table 25). It is estimated that, while asphalt paving costs between \$0.50 and \$1.00 per square foot installed, interlocking concrete paving blocks can range anywhere from \$5.00 to \$10.00 per square foot. However, given that porous asphalts can help reduce overall storm water infrastructure costs, the total costs of site development can be significantly reduced, especially when considering the savings associated with potentially eliminating storm water management ponds. Clearly, any comparison of the costs of alternative versus traditional pavements should factor in total land development costs.

Some manufacturers are now producing pervious concrete products that decrease runoff and encourage infiltration. Pervious pavement such as porous asphalt or concrete can also decrease storm water conveyance costs and increase environmental quality. It is estimated that pervious pavements such as porous asphalt cost approximately 10 percent more than conventional nonporous asphalts. To maintain their efficiency and porosity, pervious pavements and pavers require regular maintenance to remove accumulated sediment and dirt.

4.3.6 ALTERNATIVE LOT SHAPES

Individual house lots are usually regularly shaped, that is, rectangular or square, and each lot has direct access to the street. In their attempt to conserve open space and reduce developed areas, low impact developments sometimes call for alternative lot shapes, including flag, zero-lot-line, Z- and angled Z-, or zipper lots. Figure 24 provides basic diagrams of alternative lot designs.

Flag lots, sometimes referred to as pipestem lots, mesh well with the concept of shared driveways. They accommodate a house or houses built behind another house, with one common driveway leading to the street. Flag lots are sometimes used to give developers

access to unused, landlocked spaces that are not preferred agricultural or conservation areas. The Center for Urban Policy Research defines a flag lot as a large lot not meeting minimum road frontage requirements and where access to the public road is by a narrow, private right-of-way or driveway. Zero-lot-line lots provide for greater usable yard space on each lot. The lots locate one side of the house on the lot line while the other side of the house faces the usable space. Interspersing various innovative lot types in a community can help developers incorporate passive solar design into house designs.

Z- or angled Z-lots are similar to zero-lot-line lots except that they are angled by about 30 to 40 degrees, allowing developers to alternate side- and front-loaded garages. In a zipper lot, the minimum rear setback is zero, and the rear yard depth varies to concentrate usable space on the side of the lot.

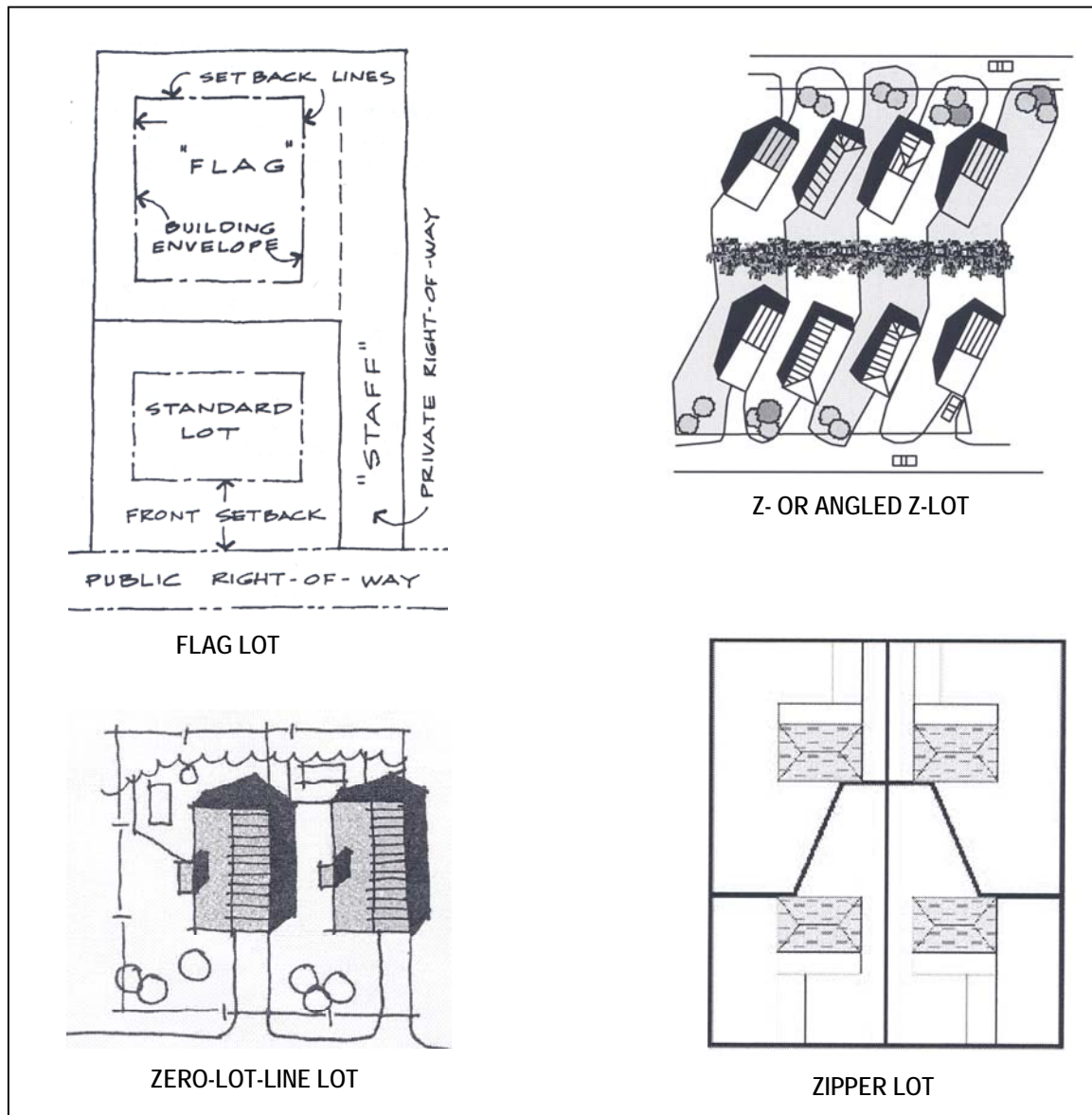

FIGURE 24. ALTERNATIVE LOT DESIGNS

4.4 ADDITIONAL RESOURCES

Additional resources that provide more detail on circulation and design are listed below. The resources are not provided as endorsements, merely as educational and reference tools. Given regional variations in climate and land development needs, we have included regional-specific resources. It is important to note, however, that addresses, especially Internet links, are subject to change. This list contains the latest links and addresses as of the printing of this publication.

Circulation Design and Resources

City of Portland Department of Transportation

<http://www.trans.ci.portland.or.us/trafficcalming/devices/skinnystreets>.

Information on Portland's Skinny Streets Program, including local traffic streets, queuing streets, and traffic-calming measures.

Geometric Design Practices for European Roads

http://international.fhwa.dot.gov/Pdfs/Geometric_Design.pdf

Practices and procedures in roadway geometric design and contextual design that seek a balance among safety, mobility, and community interests.

Sierra Club

<http://www.sierraclub.org/sprawl/articles/narrow.asp>

Web site discusses the value of narrow streets for slowing traffic, reducing vehicular crashes, and increasing neighborhood safety.

Organizations and Internet Resources

Center for Livable Communities

<http://lgc.org/clc>

Guidebook on how to implement designs for safe, efficient, and aesthetically pleasing streets.

Institute of Transportation Engineers

<http://www.ite.org>

Publications focusing on traditional neighborhood design and circulation patterns, including street space, connectivity, emergency access, parking, safety, and geometric design.

Local Government Commission

<http://lgc.org/clc/>

Publication on local communities' insight into how to implement local street initiatives.

The Conservation Fund

<http://www.conservationfund.org/>

In partnership with the Urban Land Institute (<http://www.uli.org>), a workshop entitled "The Practice of Environmentally Sensitive Development" covers the full range of project planning, design, and construction.

Walkable Communities, Inc.

<http://walkable.org>

A nonprofit group that helps Florida communities become more walkable and pedestrian-friendly.

Publications

Longmont, Colorado, Street Study

A study by Swift and Associates correlating 20,000 accident reports over an eight-year period with 13 variables associated with the street. <http://members.aol.com/phswi/swift-street.html>

Residential Streets

A comprehensive design publication for residential streets published jointly by the National Association of Home Builders (NAHB), American Society of Civil Engineers (ASCE), and the Urban Land Institute (ULI). (800) 321-8050.

<http://www.builderbooks.com>

Roundabouts: An Informational Guide

A comprehensive source of information on modern roundabouts and their uses. (301) 577-0818.

Street Design Guidelines for Healthy Neighborhoods

<http://lgc.org/clc>

A publication of the Center for Liveable Communities to help communities implement guidelines for safe, efficient, and aesthetically pleasing streets for vehicular and pedestrian traffic.

Traditional Neighborhood Development Design Guidelines: Recommended Practice

A publication of the Institute of Transportation Engineers on neighborhood and street design, including sections on street space, connectivity, emergency access, parking, safety, and geometric design.

Regional-Specific Resources

Northeastern United States

Conservation Law Foundation

“Take Back Your Streets” focuses on the history of road design and its legal aspects in New England. (617) 350-0990.

Southeastern United States

Montgomery County, Maryland

Residential traffic-calming program to help reduce speeding and improve the residential environment.

<http://www.dpwt.com/TraffPkgDiv/triage.htm>

Walkable Communities

A 12-step program by the Florida Department of Transportation to encourage safe travel

for pedestrians and vehicles.
<http://www.sustainable.doe.gov/pdf/walkable.pdf>

Western United States

Citizens for Sensible Transportation

<http://cfst.org/>

A nonprofit group in Oregon that offers several publications on traffic calming and neighborhood livability.

Reclaiming Our Streets Task Force

<http://www.trans.ci.portland.or.us/trafficcalming/reports/ArterialProgram/cover.htm>

Community action plan to implement neighborhood transportation- calming techniques in the Portland, Oregon, area.

APPENDIX A - GLOSSARY

Aerobic--Having molecular oxygen as a part of the environment or growing or occurring only in the presence of molecular oxygen, as in aerobic microorganisms.

Anaerobic--Characterized by the absence of molecular oxygen or growing in the absence of molecular oxygen (as in anaerobic bacteria).

Best Management Practice (BMP)--A structural device or practice designed to mitigate the effects of storm water runoff to attenuate flooding, reduce erosion, and reduce pollution. BMPs include a variety of **Low impact development** practices such as bioretention, sand filters, and infiltration trenches.

Bioretention--A structural storm water practice that uses soils and vegetation to treat pollutants in urban runoff and to encourage infiltration of storm water into the ground.

Buffer--Area in its natural state left between development and a shoreline, wetlands, or stream to protect water quality. Development is restricted in a buffer zone.

Community Wastewater Treatment System--Term commonly used to describe an aerobic treatment unit serving multiple dwellings or an education, health care, or other large facility.

Cul-de-Sac--A residential street terminating in a closed, circular dead end that allows vehicles to turn around.

Curvilinear Street Pattern--A street layout that follows the natural contours of the site and relies on curving roadways and cul-de-sacs to reduce vehicle speeds and cut-through traffic.

Environmentally Sensitive Development--Development intended to conserve, protect, and enhance a site's natural resource systems through careful planning and design of site elements.

Eutrophication--A phenomenon caused by excessive plant nutrients in which waterbodies are deprived of oxygen and become uninhabitable for aquatic life. Streams and lakes receive excessive amounts of plant nutrients (primarily phosphorus, nitrogen, and carbon) in various ways. Runoff from agricultural fields, field lots, urban lawns, and golf courses are common sources of the nutrients. Untreated or partially treated domestic sewage is another major source.

Green Infrastructure--A strategically planned and managed network of wilderness, parks, greenways, conservation easements, and working lands with conservation value that supports native species, maintains natural ecological processes, sustains air and water resources, and contributes to the health and quality of life for America's communities and people (see <http://www.greeninfrastructure.net/Intro/Definition.htm>).

Groundwater--Water that is underground in cracks and spaces in soil, sand, and rocks. The layers of soil, sand, and rocks are also known as aquifers. Groundwater is used for drinking water by more than 50 percent of the U.S. population, including almost all residents of rural areas.

Hybrid Street Network--A street layout that is a mix between a traditional grid pattern and a curvilinear pattern. It can reduce a community's overall street length while still providing the functions of access, circulation, and parking.

Impervious Area--Any area in the landscape that cannot effectively allow the absorption and infiltration of rainwater into the ground.

Impervious Cover--Any surface in the built environment that prohibits the percolation and infiltration of rainwater into the ground.

Jurisdictional Wetlands--A wetlands or other water of the United States regulated under the Clean Water Act.

Low Impact Development (LID)--An approach to land development that uses various land planning and design practices and technologies for simultaneously conserving and protecting natural resource systems and reducing infrastructure costs.

Nonpoint Source Pollution--Water pollution caused by rainfall washing over and through land surfaces and carrying with it pollutants from the human environment. The Clean Water Act regulates nonpoint source pollution, which differs from point-source pollution.

Open-Section Roadway--A roadway that is constructed with gravel shoulders and grassed swale systems, instead of with curb and gutter systems, to convey storm water.

Open Space--Land set aside to remain undeveloped for a community's public use and enjoyment.

On-Site Wastewater Treatment System (OWTS)--A system that relies on natural processes and/or mechanical components to collect, treat, and disperse/discharge wastewater from individual dwellings or buildings.

Queuing Street--A street sufficiently wide for one travel lane and one parking lane that forces one of two passing automobiles to yield temporarily. These streets accommodate all the functions of normal streets, including emergency access, and reduce impervious areas and therefore storm water runoff.

Resource-Efficient Development (RED)--An innovative land development approach that incorporates environmental considerations into the land planning and design process to minimize impacts on local resources.

Right-of-Way--The width of the total land area required for street paving, curb and gutter, utilities, sidewalks, and street trees. Right-of-way widths should be the smallest measurement possible that accommodates these uses.

Riparian--Of or pertaining to stream systems or stream corridors. Riparian areas usually include a stream channel, its banks, the floodplain, and associated vegetated buffers.

Sand Filter--A packed-bed filter of sand or other granular material used to provide advanced secondary treatment of settled wastewater or septic tank effluent. Sand/media filters consist of a lined (e.g., impervious PVC liner on sand bedding) excavation or structure filled with uniform washed sand that is placed over an underdrain system. The wastewater is dosed onto the surface of the sand through a distribution network and allowed to percolate through the sand to the underdrain system, which collects the filter effluent for further processing or discharge.

Sedimentation--The transport, deposit, and accumulation of soil material by wind and water. Sedimentation is usually associated with the accumulation of soil material in waterbodies.

Septic Tank--A buried tank, designed to be watertight, that is constructed to receive and partially treat raw wastewater. The tank separates and retains settleable and floatable solids suspended in the raw wastewater. Settleable solids form a sludge layer at the tank bottom. Grease and other light materials float to the top to form a scum layer. The removed solids are stored in the tank, where they undergo liquefaction, which partially breaks down organic solids into dissolved fatty acids and gases. Gases generated during liquefaction are normally vented through a building's plumbing stack vent.

Setback--The minimum distance that design elements must be placed from other elements. For example, houses usually have front, side, and rear yard setbacks from streets and other buildings.

Sheetflow--The movement of rainwater across the surface of the landscape in response to topographic conditions.

Storm water Management--An integrated system of practices and techniques for managing the safe and efficient handling of post-development rainwater.

Subdivision--The process of dividing land into smaller parcels to accommodate housing, roads, open spaces, and utilities.

Swale--A small, linear topographic depression used to move water from one location to another.

Variance--A request to a zoning authority to deviate from the approved development ordinances of a particular area. For instance, a variance might be requested to waive a 40-foot front yard setback so that houses might be sited closer to the street.

Wastewater Treatment Facility--A wastewater treatment facility collects waste streams from residential, commercial, and industrial sources through sewer systems and treats the water to prescribed levels before release into a waterbody.

Zoning--Regulations governing the use, placement, spacing, and size of land and structures within a specific area.

APPENDIX B—CASE STUDIES

Appendix B contains the following case studies:

- Chancery on the Lake
- Duke Street Square
- Kensington Estates
- Phillippi Creek Septic System Replacement Program
- Ron Tyne and Associates
- Somerset Community

CHANCERY ON THE LAKE

Chancery on the Lake is a condominium development centered around a 14-acre wet pond. The lake is marketed as a feature of the development, resulting in an increased sales pace relative to that of competitors. In fact, the developer realizes a premium of \$7,000 to \$10,000 per lakefront unit.



VIEW OF THE WALKWAY, PICNIC AREA, AND LAKE

Specifics

- Seven-acre, 170-unit condominium development in Alexandria, Virginia, centered around a large urban runoff pond.
- Prices for the condominiums range from \$129,990 to \$139,990 (Frederick et al., 1995).
- 14-acre pond surrounded by picnic tables, a gazebo, and a walking trail, with a fishing pier planned for construction (Frederick et al., 1995).
- \$7,000 to \$10,000 premium for condominiums fronting on the lake (Flora, 1997).
- Above-average sales pace for the area and the condominium market; a significant number of sales from buyers who shopped around and then were attracted to Chancery because of the lake (Flora, 1997).
- Pond marketed as a selling point (Flora, 1997).
- Lake constructed by damming an existing creek, with some excavation of the surrounding area to achieve the desired shape and volume.
- No maintenance required other than mowing grassed areas, visual inspections of the dam and lake, and sediment removal from the rip-rap outfall structure (Scalia, 1997).

References

- Debora Flora, Sales Manager, Chancery Associates Limited Partnership. Alexandria, VA. (703) 922-7171, personal communication.
- Vic Scalia, Halle Enterprises. Silver Spring, MD. (301) 495-1520, personal communication.

DUKE STREET SQUARE

Duke Street Square uses a sand filter, which is a best management practice, to filter pollutants out of storm water runoff. At this urban site, buildable land was at a premium. An underground sand filter satisfied storm water management requirements without consuming buildable land area. The developer was able to add five to seven townhomes that would have been lost to land for a pond.



VIEW OF THE INSIDE OF A SAND FILTER SIMILAR TO THE ONE
INSTALLED AT DUKE STREET SQUARE

Specifics

- 40-unit townhouse development in Alexandria, Virginia.
- Off-line sand filter system serves 1.38 impervious acres.
- Parking lot designed with grate inlets connected to underground pipes that carry storm water to the sand filter. Flows in excess of 0.5 inches of rainfall in a single event are diverted to the city sewer system.
- The filter's concrete chamber was cast in place (Keller, 1997).
- Underdrains transport filtered water to the city storm sewer system (Keller, 1997).
- Northern Virginia land prices of approximately \$40 per square foot make it costly to install dry ponds, wet ponds, or storm water wetlands (Bell, 1997); the sand filter system uses no buildable area.
- Townhouse total includes between five and seven townhouses that normally would have been lost to land needed for a dry pond (Teets, 1997).

Cost Data

- Construction of the sand filter totaled \$41,030, including the dry vault sand filter, two monitoring manholes, pipes with connections, and the sand filter itself (\$35,197). The entire system cost \$29,732 per impervious acre while the sand filter alone cost \$25,505 per impervious acre.

- Filter's sand bed will need replacement approximately every five years.
- System will need periodic inspection and removal of accumulated trash from grate inlets, pre-treatment structure, and filter bed.

Community Acceptance

- The homeowner association has set aside money for routine and nonroutine maintenance.

References

- Glenn Teets, Project Manager, Wills Company. Vienna, VA. (703) 760-9600.
- R.J. Keller, L.S. Project Manager, R.C. Fields, Jr., and Associates, P.C. Alexandria, VA. (703) 549-6422.
- Warren Bell, City Engineer, City of Alexandria. Alexandria, VA. (703) 838-4327.

KENSINGTON ESTATES

At Kensington Estates the use of LID technologies in a conventional, 103-lot single-family development planned on 24 acres in unincorporated Pierce County were evaluated. The site was characterized by poor soils. The development took advantage of the new Western Washington Storm Hydrology Model (WWHM) to illustrate the full range of LID technologies in the site's redesign.

Specifics

- Maintained lot yield of 103 lots.
- Designed a roadway system adequate for emergency vehicles.
- Achieved "zero" effective impervious surfaces.
- Incorporated full range of LID techniques, including soil rehabilitation, rain gardens, bioretention, and pervious pavement;
- Provided adequate off-street parking.
- Reduced total project impervious pavement.
- Minimized piped conveyance.

Cost Data

A cost evaluation of the redesign further illustrated the potential benefits of LID. Overall, the LID project permitted construction cost savings of over 20 percent over the conventional project. It achieved the largest share of savings by reducing the size of the storm pond structures and eliminating catchments and piped storm conveyance. Excavation and erosion control costs were also significantly reduced.

Even though the LID design called for a roadway width of 20 feet, the proposed use of porous paving material and of "looped" cul-de-sac clusters designed for emergency vehicle access made the costs associated with roadways and utilities roughly equal to or slightly higher than the costs for conventional materials and design.

PHILLIPPI CREEK SEPTIC SYSTEM REPLACEMENT PROGRAM

In Sarasota, Florida, available and applicable on-site wastewater treatment and collection technologies were evaluated (see Figure 25) to determine their potential for improving current wastewater treatment and disposal practices in Phillippi Creek.

Specifics

- Available technologies were grouped into three major categories for evaluation: natural systems (e.g., conventional septic tank and subsurface wastewater infiltration systems [SWIS] and septic tank and subsurface drip irrigation [SDI] systems); engineered biological systems (e.g., suspended growth systems, submerged biofilters, and unsaturated biofilters); and waste segregation systems (e.g., nonwater carriage toilets and on-site greywater treatment systems).
- Based on the number of connections, total flow, and available treatment plant and transmission capacities, the project area was previously divided into sixteen (16) manageable areas referred to as Wastewater Project Improvement Areas (WPIA).
- The cost analysis addressed natural systems and engineered biological systems but, because of a variety of implementation problems, including community acceptance, did not address waste segregation systems.



FIGURE 25. EVALUATION PROCESS FOR COMPARING COLLECTION AND ON-SITE WASTEWATER TREATMENT SYSTEM ALTERNATIVES

Cost Data

- The capital cost of a septic tank with a mound with 12-inch fill was \$6,000.
- The capital cost of a septic tank with subsurface drip irrigation with 12-inch fill was \$7,900.
- In terms of uniform annual cost, the septic tank with SWIS mound was the most cost-effective alternative in a low-density area. In medium- and high- density areas, the vacuum sewer system was the most cost-effective alternative.

RON TYNE AND ASSOCIATES

Terry Paff, president of Metropolitan Realty and Development in Sherwood, Arkansas, wanted to create a development that appealed to both the general public and permitting and review officials. He approached Ron Tyne of Tyne & Associates with his idea and hired the consultant to redesign a conventional site plan developed for a 130-acre parcel. The case study underscores two important points. First, at project inception, developers must formulate a vision of what they want to achieve. They then need to communicate that vision to everyone involved in and affected by the project. Second, by reducing infrastructure costs and collaborating with public officials, a developer can realize a net increase in a project's lot yield.

Specifics

- The new design worked with the land's features. For instance, streets flowed with the terrain, minimizing excavation needs; drainage areas were preserved and buffered by greenbelts.
- Existing drainage courses form a network of green spaces called greenbelts that are connected by neighborhood hiking trails.
- Maximizing the number of lots that backed up to the greenbelts addressed concerns about privacy.
- The original plan's collector street was changed to include green space buffers and traffic-calming circles, thus allowing the developer to reduce street widths from 36 to 27 feet. In addition, trees were allowed to stay close to the curb line.
- The site uses native vegetation such as buffalo grass. Cleared trees were transformed into mulch.
- The original plan preserved 1.5 acres of green space while the revised plan saved 23.5 acres.
- Some of the development cost savings went to fund a neighborhood park with picnic facilities, a pavilion, and ball fields.

Cost Data

- Overall, the developer made an additional profit of \$2.2 million on the project by using the practices above.

References:

- "Bridging the Gap: Developers Can See Green," *Land Development Magazine*, Spring/Summer 2000, pp. 27-31.
- The ToolBase PATH Technology Inventory provides information on low impact development:
<http://www.toolbase.org/tertiaryT.asp?CategoryID=1008&DocumentID=2007>

SOMERSET COMMUNITY

In a typical suburban development in Prince George's County, MD, the developer incorporated shallow landscaped depressions called bioretention areas, also known as rain gardens (see Figure 26), into each lot to control storm water quantity and quality. The bioretention areas eliminated the need for a storm water pond, allowed the development of six extra lots, and resulted in a cost savings of more than \$4,000 per lot.



A TYPICAL BIORETENTION AREA IN SOMERSET

Specifics

- 80-acre site in Prince George's County, Maryland, undergoing development into 199 homes on 10,000-square-foot lots.
- Prices begin at \$160,000.
- Bioretention areas range between 300 and 400 square feet, with one to two bioretention areas per lot (Daniels, 1995).
- Bioretention areas located at low points on lots (see Figure 27).
- Water allowed to pool to a depth of six inches in the bioretention areas after each rain event; complete infiltration of ponded water achieved within 48 hours (Daniels, 1995).
- Bioretention areas combined with grassed swales to replace curbs and-gutters.
- Total cost approximately \$100,000 compared with nearly \$400,000 for the storm water ponds originally planned (Daniels, 1995).
- Six more lots added to the development, thus increasing revenue (Daniels, 1995).
- Eliminated traditional curbs and gutters and storm water pond by using the less expensive alternative of bioretention areas and grassed swales.
- Development marketed as environmentally friendly. When told that they were helping preserve the Chesapeake Bay, homeowners and potential buyers became excited and interested in helping (Coffman, 1997).
- Bioretention areas perceived by homeowners as free landscaping (Coffman, 1997).
- Total cost for each bioretention area is \$500 (\$150 for excavation and \$350 for plants) (Daniels, 1995).



INDIVIDUAL BIORETENTION AREA

Cost Data

Description	Storm water Management Pond/Curb and Gutter Design	Bioretention System
Engineering Redesign	\$0	\$110,000
Land Reclamation (6 lots x \$40,000 net)	\$0	<\$240,000>
Total Costs	\$2,457,843	\$1,541,461
Total Costs--Land Reclamation <i>plus</i> Redesign Costs	\$2,457,843	\$1,671,461
Total Cost Savings = \$916,382		
Cost Savings per Lot = \$4,604		

Source: Winogradoff, 1997.

Table 26. Cost Comparison of Conventional Storm Water System versus Bioretention

Community Acceptance

Somerset residents have enthusiastically accepted their bioretention areas. Homeowners are actively maintaining them and have lodged few complaints. Only one bioretention area has experienced functional problems, which probably resulted from the diversion of too much water. Safety issues or mosquitoes have not been a problem.

References

- Ayres Associates. "Evaluation of On-Site Wastewater Treatment and Wastewater Collection System Alternatives." TM No. 7 report. http://www.co.sarasota.fl.us/environmental_services/pcssrp/pdfs/40075r048.pdf
- Larry Coffman, Department of Environmental Resources. Prince George's County, MD. (301) 883-5834.
- L. Daniels. "Maryland Developer Grows 'Rain Gardens' to Control Residential Runoff," *Nonpoint Source News-Notes*, 42 (August/September) 1995.
- W.K. Curry. and S.E. Wynkoop, eds. *How Does Your Garden Grow?: A Reference Guide to Enhancing Your Rain Garden*. Landover, MD: Prince George's County Department of Environmental Resources, 1995.

APPENDIX C - REFERENCES

- American Association of State Highway & Transportation Officials (AASHTO), *Green Book*, American Association of State Highway & Transportation Officials, 1994.
- American Planning Association, *Growing Smart Legislative Guidebook: Model Statutes for Planning and the Management of Change*, 2002 ed., American Planning Association, 2002.
- Arendt, Randall G., *Conservation Design for Subdivisions: A Practical Guide to Creating Open Space Networks*, Island Press, 1996.
- Argonne National Laboratory, *Peconic River Remedial Alternatives--Wetlands Restoration/Constructed Wetlands*, Argonne National Laboratory, June 2001.
- Beneficial Designs, Inc., Julie B. Kirschbaum et al., *Designing Sidewalks and Trails for Access Part II of II: Best Practices Design Guide*, U.S. Department of Transportation, Federal Highway Administration, 2001.
- Burden, Dan and Paul Zykofsky, *Emergency Response: Traffic Calming and Traditional Neighborhood Streets*, Local Government Commission Center for Livable Communities, 2001.
- California EPA Press Release, August 17, 1999.
- CART, *Traffic Calming: The Solution to Urban Traffic and a New Vision for Neighborhood Livability*, CART, 1989.
- Center for Watershed Protection, *Better Site Design: A Handbook for Changing Development Rules in Your Community*, Maryland, 1998.
- Center for Watershed Protection, *Site Planning for Urban Stream Protection*, Ellicott City, MD, Prepared for the Metropolitan Council of Government, Washington, DC, 1995.
- Chesapeake Bay Program, *Storm Water Management and the Chesapeake Bay*, Fact Sheet, September 9, 2001.
- Curry, W.K. and S.E. Wynkoop, eds., *How Does Your Garden Grow? A Reference Guide to Enhancing Your Rain Garden*, Prince George's County, Maryland, Department of Environmental Resources, 1995.
- , Department of Natural Resources, *Small Site Erosion and Sediment Control Guidance*, October 27, 1999, www.epa.gov/owow/nps/ordinance/indiana.htm.
- Derek Winogradoff, PMP, Prince George's County Programs and Planning Division, Personal Communication, 2003.
- , *The Do-It-Yourself Local Site Planning Roundtable Kit*, Center for Watershed Protection, 1999.

England, Gordon, P.E., Brevard County Surface Water; David Dee, P.E., Parsons, Brinkerhoff, Inc.; and Stuart Stein, P.E., GKY and Associates, Inc., *Storm Water Retrofitting Techniques for Existing Development*, March 2000.

Ewing, Reid, *Best Development Practices: A Primer for Smart Growth*, Smart Growth Network, 1998.

Fairfax County Department of Public Works and Environmental Services, *Guidelines for the Use of Innovative BMPS in Fairfax County, Virginia*, Fairfax County, Virginia, Department of Public Works and Environmental Services, 2001.

Federal Register Notice, March 28, 2003 (Volume 68, Number 60) Pages 15172 – 15173, <http://www.epa.gov/fedrgstr/>.

Forester Communications, Inc., *Storm water*, Forester Communications, Inc., 2000–2002.

Friends of the Rappahannock (FOR), *Growing Greener in Your Rappahannock River Watershed*, FOR, 2002.

Jarvis, Frederick D., *Site Planning and Community Design for Great Neighborhoods*, Home Builder Press of the National Association of Home Builders, 1993.

Johnston, David, *Building Green in a Black and White World: A Guide to Selling the Homes Your Customers Want*, Home Builder Press of the National Association of Home Builders, 2000.

Jones, D., J. Bauer, R. Wise, and A. Dunn, *Small Community Wastewater Cluster Systems*; Purdue University Cooperative Extension Service, July 2001. www.ces.purdue.edu/extmedia/AE/ID-265.pdf.

Kone, D. Linda, *Land Development*, 8th ed., Home Builder Press of the National Association of Home Builders, 1994.

Kulash, Walter M. and National Association of Home Builders, Urban Land Institute, American Society of Civil Engineers, and the Institute of Transportation Engineers, *Residential Streets*, 3rd ed., Urban Land Institute, American Society of Civil Engineers, and the Institute of Transportation Engineers, 2001.

Low Impact Development Center, Inc., *Bioretention Cell Costs*, Low Impact Development Center, Inc., http://www.lid-stormwater.net/biorention/bio_costs.htm.

-----, *Low Impact Development Design Strategies--An Integrated Design Approach*, Prince George's County, Maryland, Department of Environmental Resources, Programs and Planning Division, 1999.

-----, *Low Impact Development Hydrologic Analysis*, Prince George's County, Maryland, Department of Environmental Resources, 1999 and 2000.

Marsh, William M., *Environmental Analysis: For Land Use and Site Planning*, McGraw-Hill, Inc., 1978.

Maryland Department of the Environment, *2000 Maryland Storm Water Design Manual--Volume I--Storm Water Management Criteria*, Maryland Department of the Environment, 2000.

Maryland National Capital Builders Industry Association (MNCBIA), unpublished research, 2001.

National Association of County Engineers and U.S. Department of Transportation, *Training Guide Series and Action Guide Series* [CD-Rom], National Association of County Engineers and U.S. Department of Transportation, 1997.

National Association of Home Builders, *56th Annual Builders' Show--Building inside Nature's Envelope* [Tapes 1 and 2], Chesapeake Audio/Video Comm., Inc., 2000.

National Association of Home Builders and NAHB Research Center, *Building Greener, Building Better--The Quiet Revolution*, National Association of Home Builders and NAHB Research Center, 2002.

National Association of Home Builders, Erosion and Sediment Control Best Management Practices (BMPs) Research Report – Second Edition, Prepared for NAHB, Washington, DC by PBS&J, Beltsville, MD, p. 51, 2002b.

National Fire Protection Association, *NFPA 1141: Standard for Fire Protection in Planned Building Groups, 1998 Edition*, National Fire Protection Association, 1998.

National Fire Protection Association, *NFPA 299: Standard for Protection of Life and Property from Wildfire, 1997 Edition*, National Fire Protection Association, 1997.

National Institute of Building Sciences, *Land-Use Regulations Handbook*, National Institute of Building Sciences, 1990.

National Urban NPS Management Measures Guidance [CD-Rom], U.S. Environmental Protection Agency, 2002.

New Urban News, *New Urbanism and Traditional Neighborhood Development*, New Urban News, 2000.

North Central Texas Council of Governments, *Guide to Developing Naturally*, North Central Texas Council of Governments, 2001.

-----, *The Oakland/Berkeley Hills Fire*, National Wildland/Urban Information Fire Program.

-----, Office of Water, *Decentralized Systems Technology Fact Sheet-- Aerobic Treatment*, EPA 832-F-00-031, September 2000b.-----, Office of Water, *Guidance Specifying Management Measures for Sources of Nonpoint Pollution in Coastal Waters*, 1993.

-----, Office of Water, *Post-Construction Storm water Management in New Development & Redevelopment* (Part of the National Menu of Best Management Practices for NPDES

Storm water Phase II), U.S. Environmental Protection Agency, Office of Water, October 27, 2000.

-----, Office of Water, *Protecting Natural Wetlands: A Guide to Storm water Best Management Practices*, U.S. Environmental Protection Agency, Office of Water, 1996.

-----, Office of Water, Office of Wastewater Management, *Response to Congress on Use of Decentralized Wastewater Treatment Systems*, U.S. Environmental Protection Agency, Office of Water, Office of Wastewater Management, 1997.

----, Office of Wetlands, Oceans and Watersheds, Office of Research and Development, *On-Site Wastewater Treatment Systems Manual* [CD-Rom], U.S. Environmental Protection Agency, Office of Wetlands, Oceans and Watersheds, Office of Research and Development, 2000.

Petit, Jack, Debra L. Bassert et al., *Building Greener Neighborhoods: Trees as Part of the Plan*, 2nd ed., American Forest and Paper Association and Home Builder Press of the National Association of Home Builders, Washington, DC, 1998.

Prince George's County Department of Environmental Resources, *The Bioretention Manual*, Prince George's County, Maryland, Department of Environmental Resources, 2001.

-----, *Residential Drainage: A Homeowner's Guide to Drainage Problems and Solutions*, Prince George's County, Maryland, Department of Environmental Resources, 1998.

Rocky Mountain Institute, *Green Development: Integrating Ecology and Real Estate*, John Wiley & Sons, Inc., 1998.

Sikora, Jeannie Leggett, *Profit from Building Green: Award Winning Tips to Build Energy Efficient Homes*, BuilderBooks of the National Association of Home Builders, 2002.

Site Work & Landscape Cost Data, R.S. Means, 2002.

Small Flows Quarterly, Winter 2002.

-----, *Storm Water Management for Construction Activities: Developing Pollution Prevention Plans and Best Management Practices*, U.S. Environmental Protection Agency, 1992.

Storm Water Technology Fact Sheet--Bioretention, U.S. Environmental Protection Agency, 1999.

Sykes, R.D., Chapter 31 – Site Planning, UMN Press, St. Paul, 1989.

Treadway, Elizabeth and Andrew L. Reese, *Financial Strategies for Storm water Management*, Ogden Environmental and Engineering Services, Inc., 2000.

U.S. Environmental Protection Agency, *Erosion and Sediment Control Ordinance*, June 15, 1996, www.epa.gov/owow/nps/ordinance/escontrol.htm

Urban Drainage and Flood District, *Urban Storm Drainage--Criteria Manual Vols. 1 and 2* [CD-ROM], Urban Drainage and Flood District, 2001.

Virginia Department of Conservation and Recreation Division of Soil and Water Conservation, *Virginia's Erosion and Sediment Control Law, Regulations, and Certification Regulations*, Virginia Department of Conservation and Research, 2001.

Washington State Community Trade and Economic Development and Building Foundations for the Future, *Model Code Provisions--Urban Streets & Subdivisions*, Washington State Community Trade and Economic Development and Building Foundations for the Future, 1998.

Watershed Management Institute, Inc., *Operation, Maintenance, and Management of Storm water Management Systems*, Watershed Management Institute, Inc., 1997.

Wieske, Derek and Lisa M. Penna, *Storm-Water Strategy*, Civil Engineering, 2002, p. 62.

APPENDIX D – 1993 PUBLICATION'S TABLE OF CONTENTS

Foreword.....v

INTRODUCTION1

PART I - STANDARDS

Street Standards7

Storm Water Management Standards29

Temporary Sediment and Erosion Control Standards65

Site Utilities Standards.....89

Sanitary Sewage Systems Standards.....93

Water Supply Standards.....115

Miscellaneous Standards.....135

PART II - MODEL STATE ENABLING LEGISLATION

State Preemptive Standards for Land Development and Site Improvement.....139

State Land Development and Site Improvement Standards for Voluntary Adoption by
Political Subdivisions.....143

Land Development and Site Improvement Standards for Adoption by
Local Governments.....147

BIBLIOGRAPHY.....151

APPENDIX: Land Development Approval Process.....A1