

"the stars  
at night are  
big & bright"

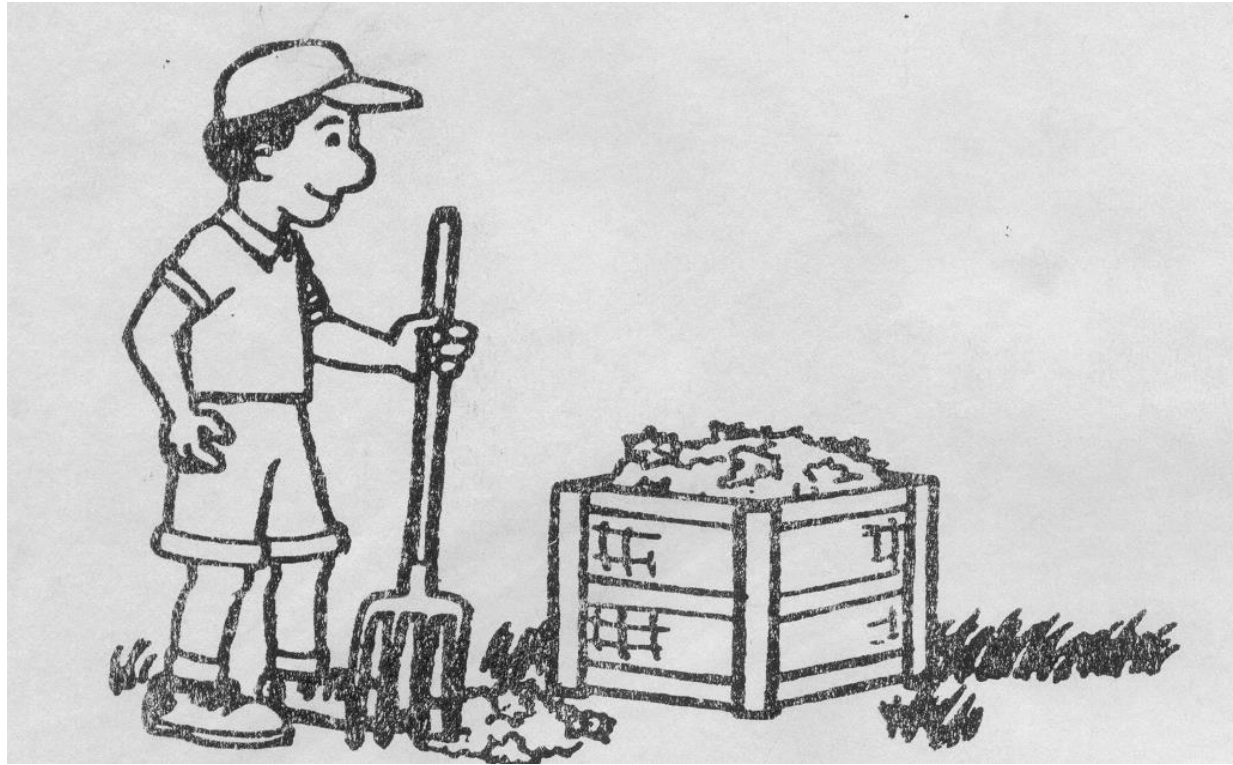



## Ellen Pedisich

Master Gardener & Master Composter

“Texas Commission on Environmental Quality”

**Don't bag it -  
Compost it!**



- **Decomposition**
  - **Composting Fundamentals**
  - **Composting Structures**
  - **Building and Maintaining a Compost Pile**
  - **Using Compost**

DECOMPOSITION-  
A NATURAL CYCLE

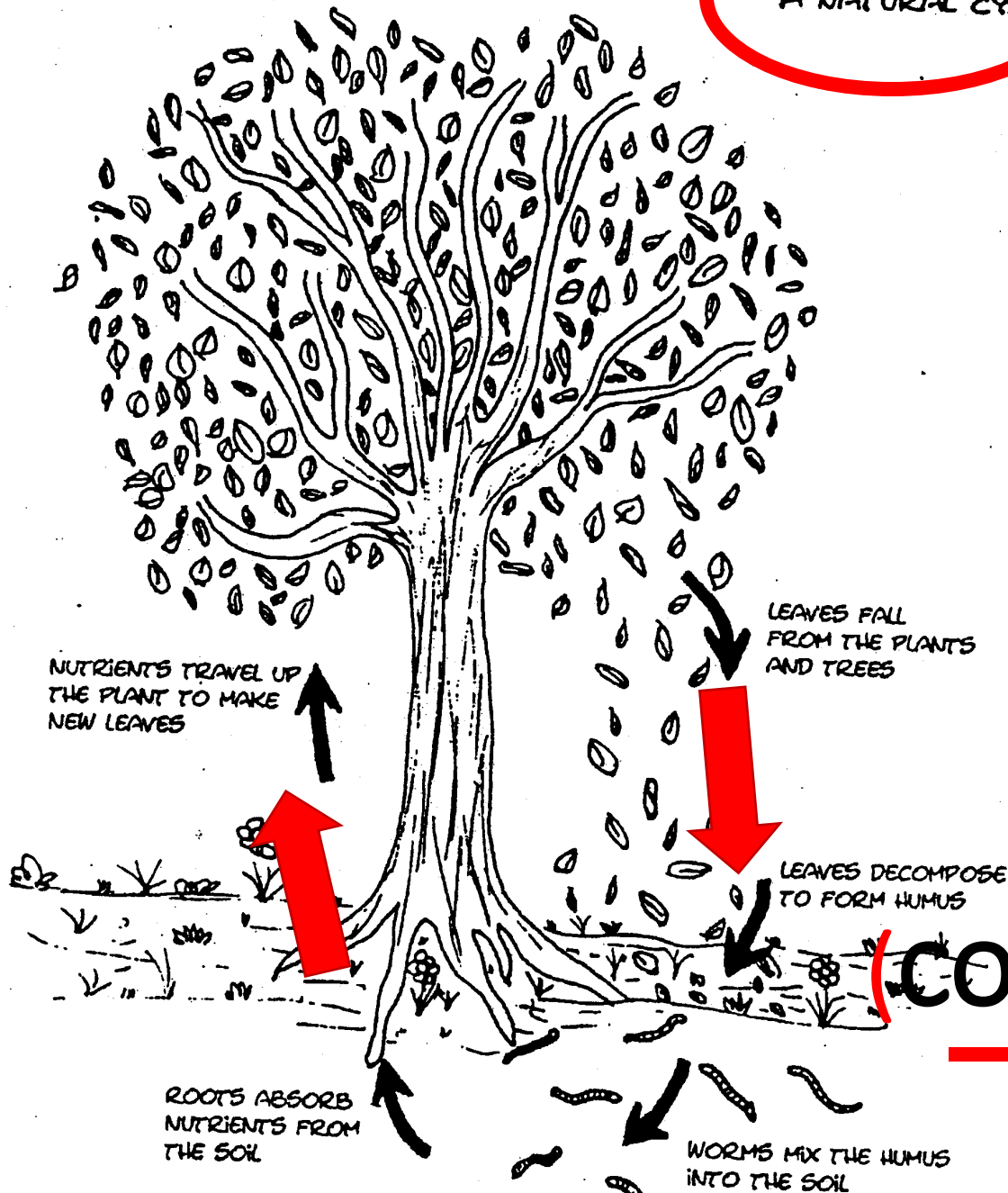

## 2.) Composting Fundamentals



Why  
compost?

To make  
**Humus!**

# Composting!! *Ages Ago*





Albert Howard

Indore method - Layering



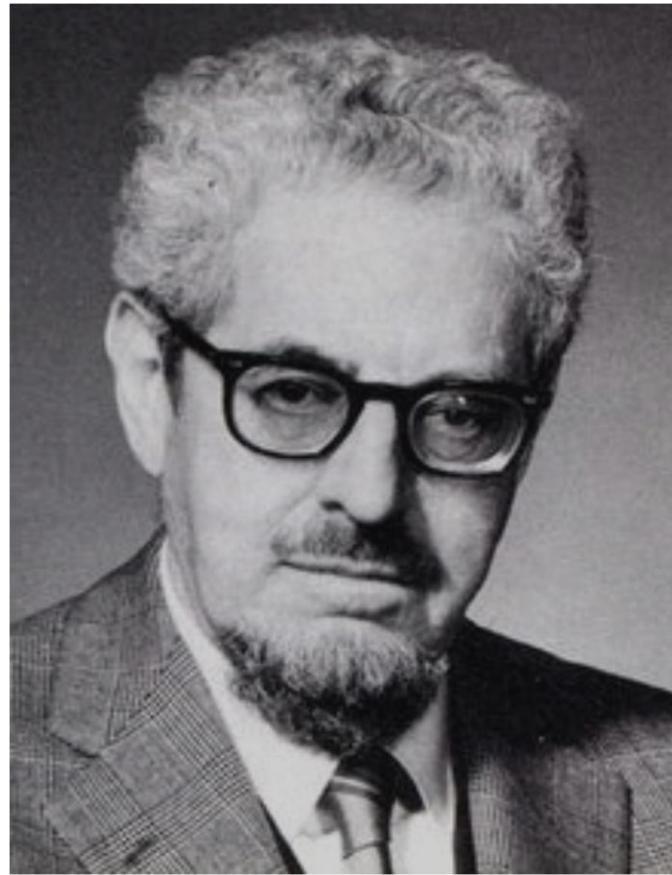

J. I. Rodale 1898-1971

**Aerobic** Mixing - Heaps!



**anaerobic decomposition**

**aerobic decomposition**

DECOMPOSITION-  
A NATURAL CYCLE

(aerobic)

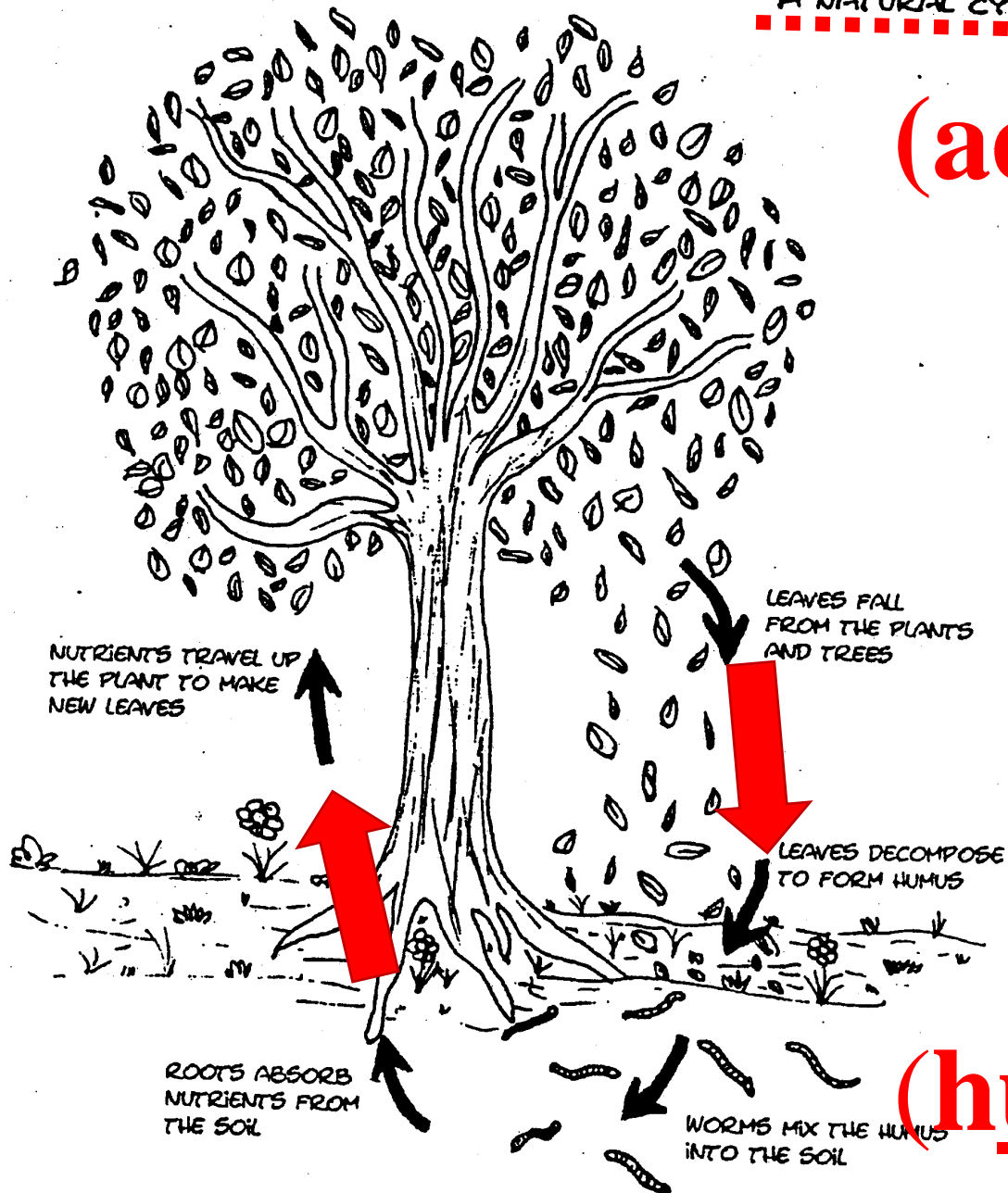

(humus)



# Air - Water - Nitrogen - Carbon



Compost should be kept  
as wet as a damp sponge.



# Particle Size Effects on Composting

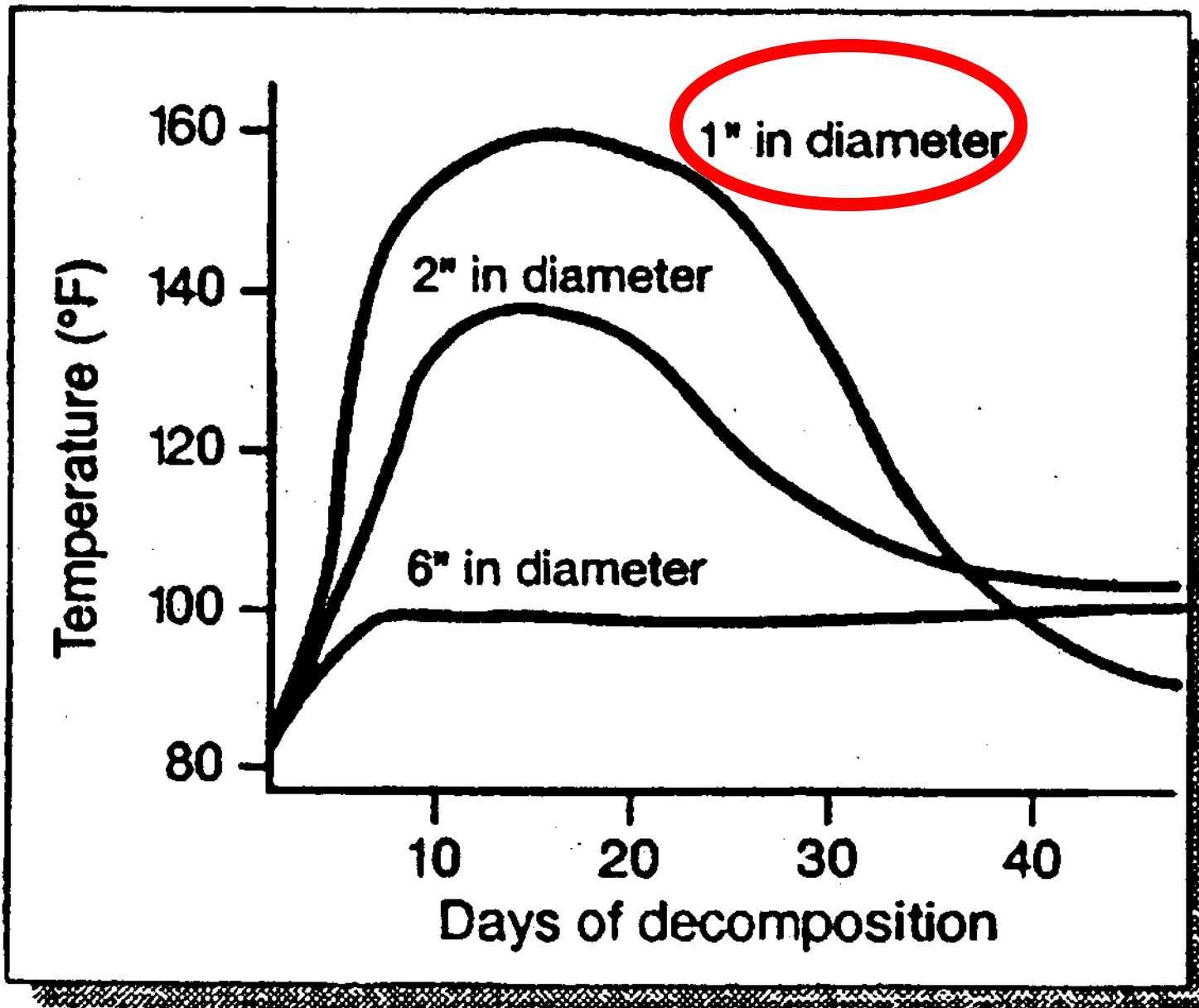

# FOOD WEB OF THE COMPOST PILE

ENERGY FLOWS IN THE DIRECTION OF THE ARROWS

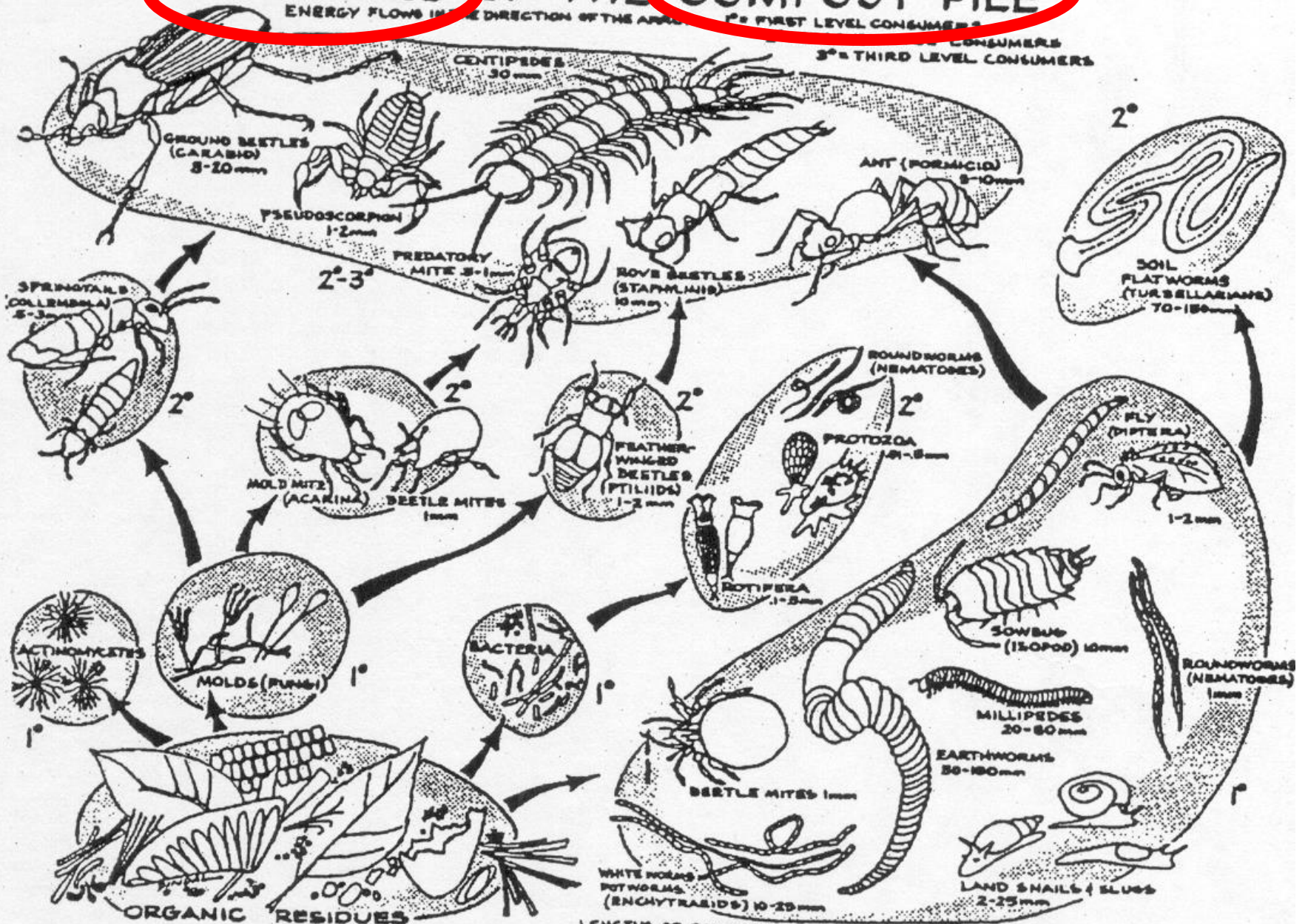

LENGTHS OF ORGANISMS GIVEN IN MILLIMETERS (25 mm = 1 in)



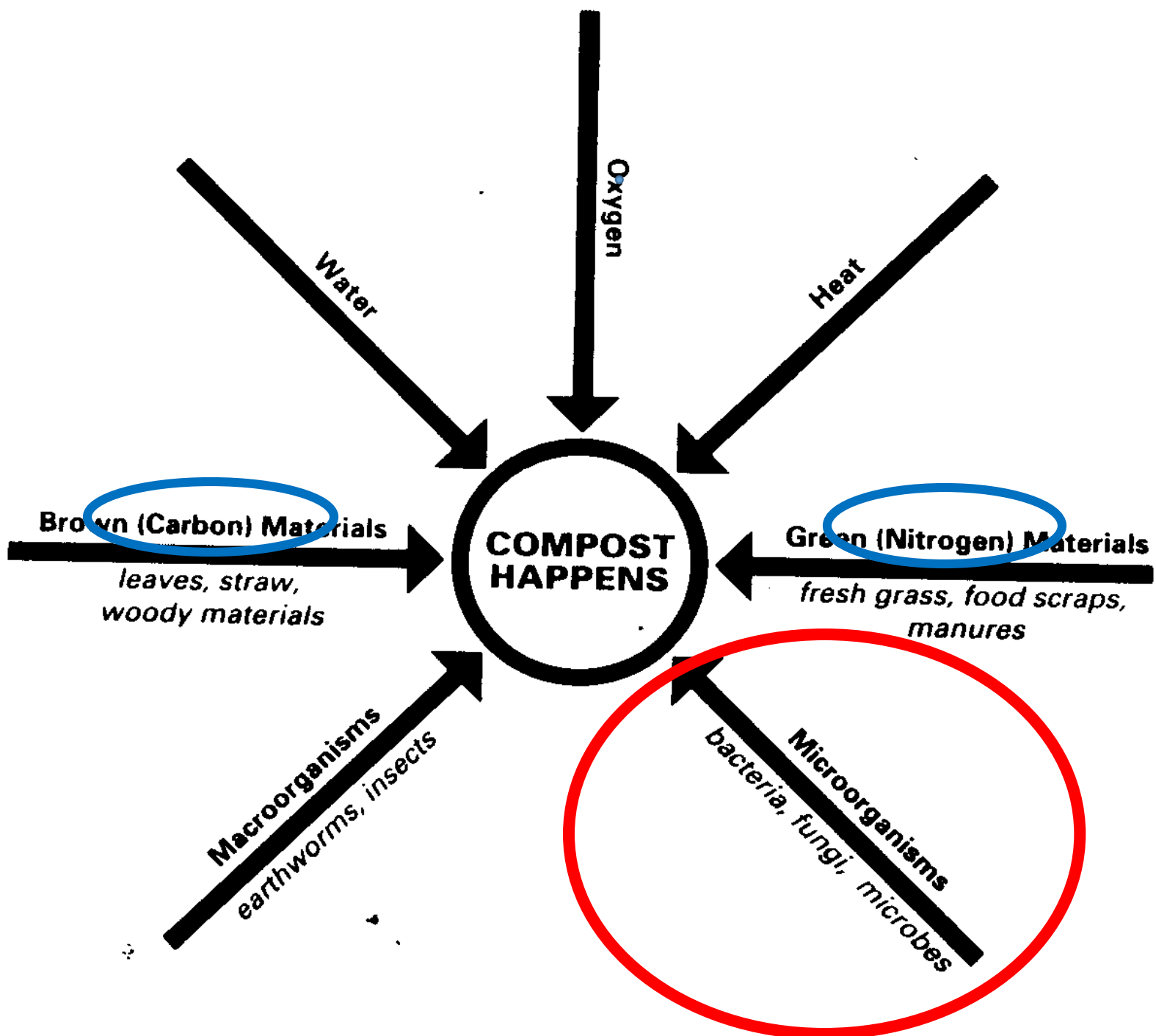



# 3.) Composting Structures

holding unit



# Garbage Can

# Barrel Drum

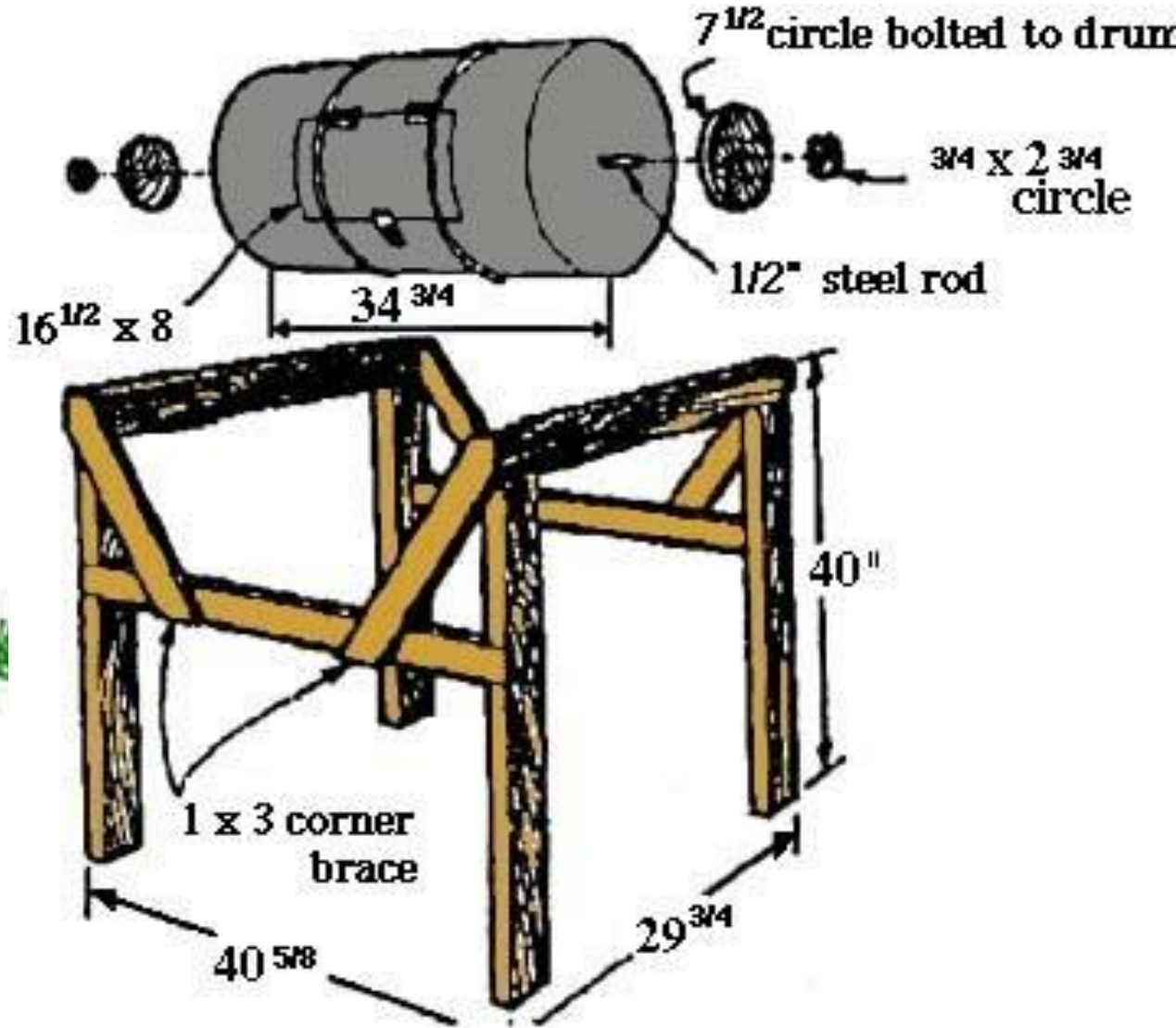
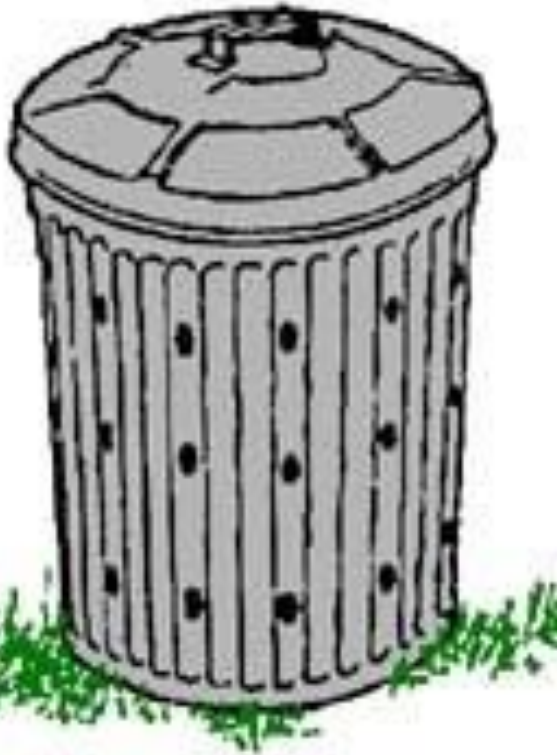

# Three Bin Turning Units:

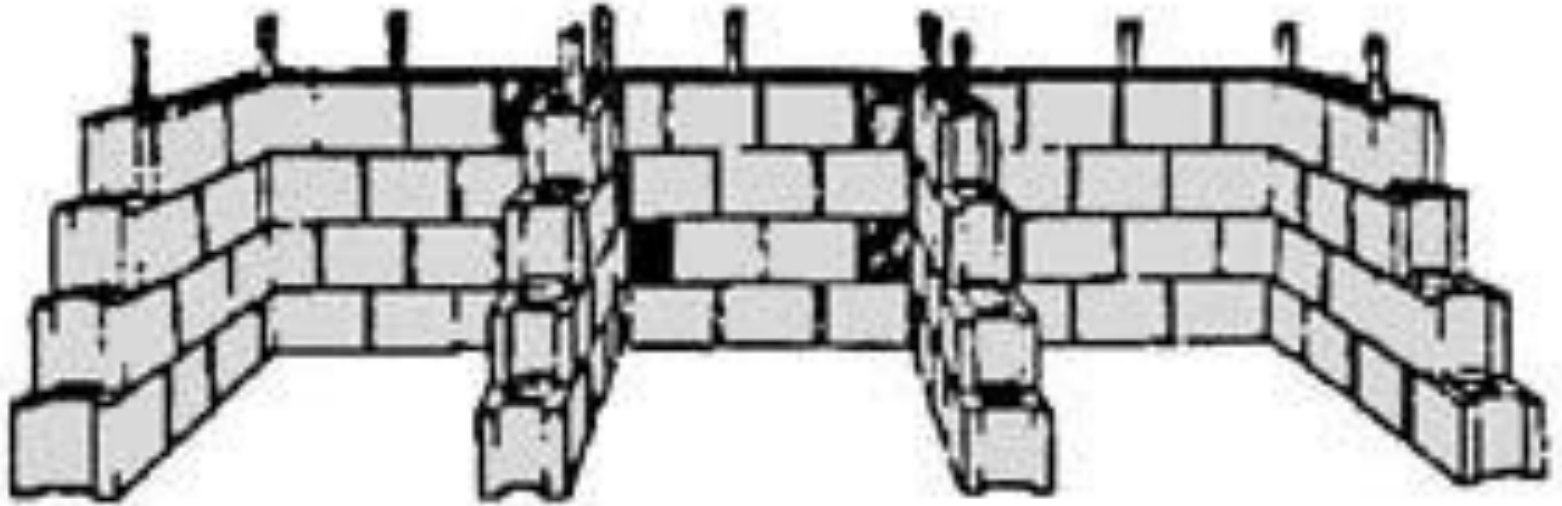

# 4.) Building and Maintaining a Compost Pile



Composting works best when different materials, both wet and dry, are mixed together.



# Turning Unit







# Black Gold



# 5.) Using Compost





**1. Carbon (brown)**

**2. Nitrogen (green)**

**3. Air**

**4. Water**

# COMPOSTING

*for Kids !*

by Robert “Skip” Richter,

County Extension Director,

Travis County,

Texas AgriLife Extension



Setting Up The Bin



**Five Containers of Ingredients**



**Watering**



“Don’t Bag It – Compost It”

(Texas A&M: 67 pages!)

“Composting for kids”

(Texas A&M: 31 pages!)

Earth-Kind Composting

and

Ten Reasons Why I Compost

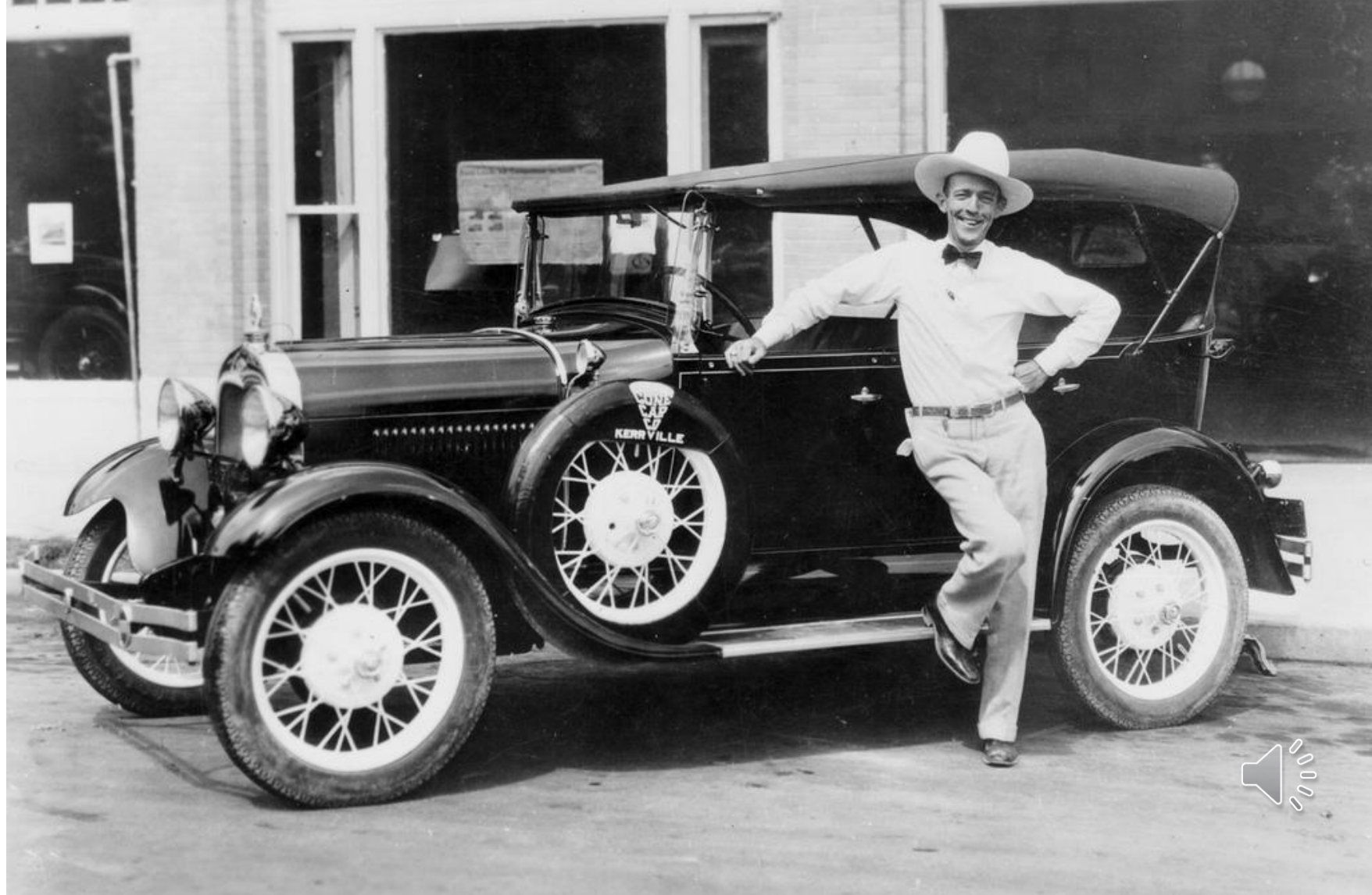

Jimmy Rodgers - Yodeling Cowboy - 1929

"the stars  
at night are  
big & bright"

