

1. PROPOSED INTERSECTION IMPROVEMENT OF AIRPORT RD AND N PORTER RD

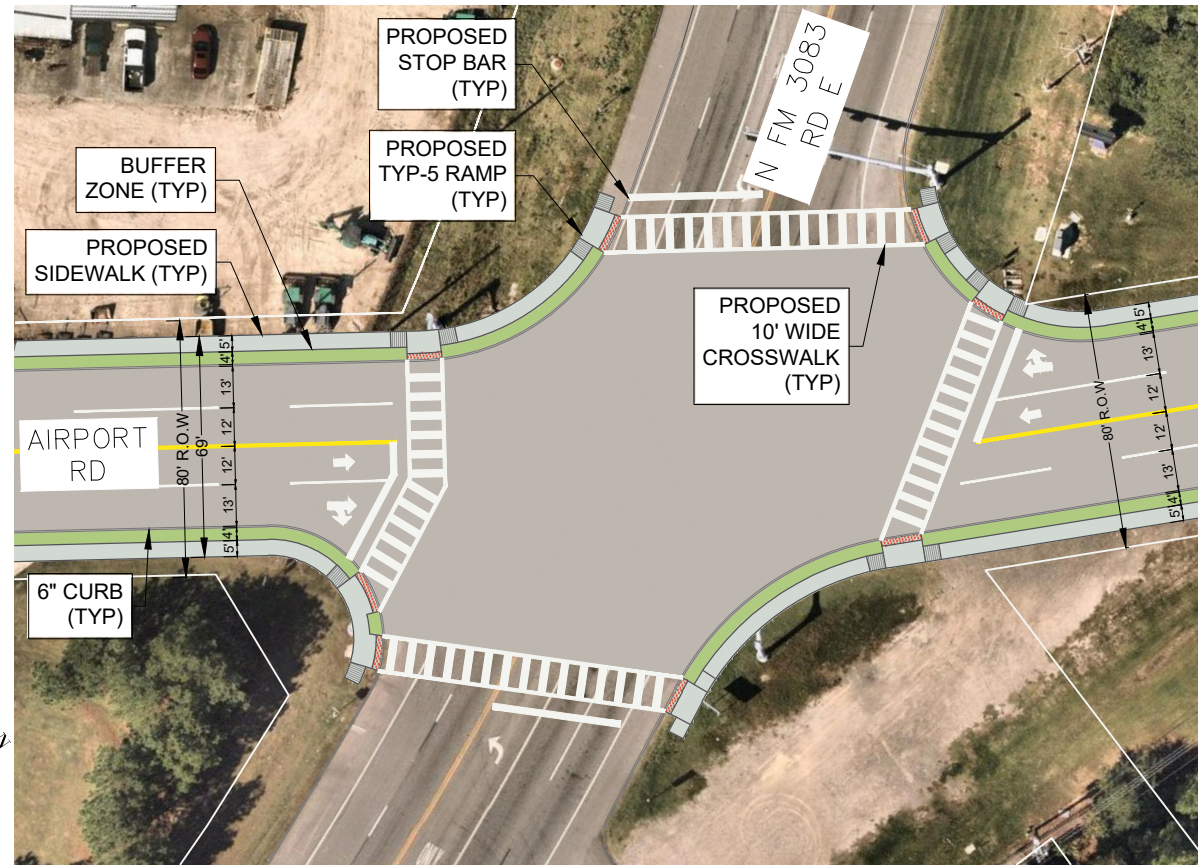

2. PROPOSED INTERSECTION IMPROVEMENT OF AIRPORT RD AND N FM 3083 RD E

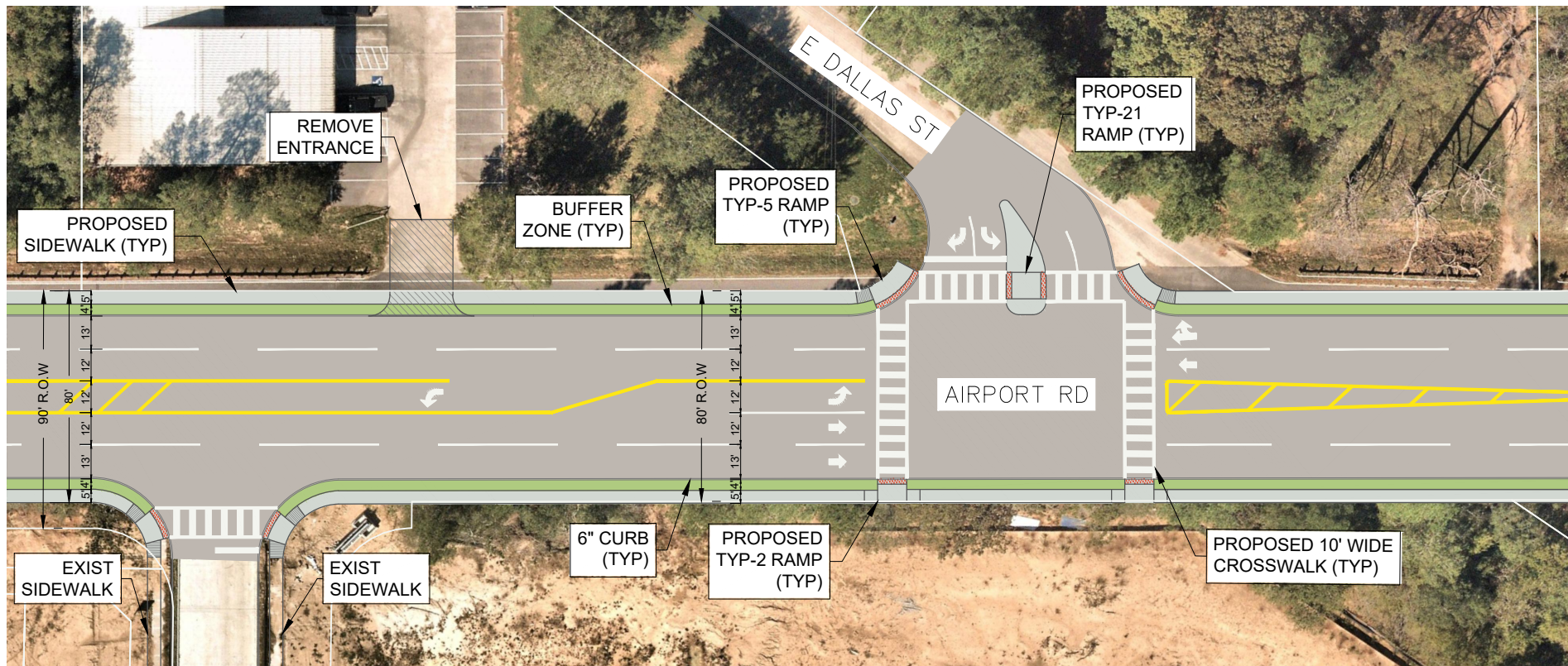

3. PROPOSED ROADWAY AND INTERSECTION IMPROVEMENT OF AIRPORT RD AND E DALLAS ST

NOTE:
R.O.W. INFORMATION IS BASED ON MONTGOMERY
CAD DATA AND REQUIRES VERIFICATION BY
SURVEYOR.

PRELIMINARY LAYOUT

EXHIBIT
 1 OF 2

SCALE: N.T.S. | REV: C

DATE: 01/12/2022

DWG BY: BI

CHK BY: ET & AG

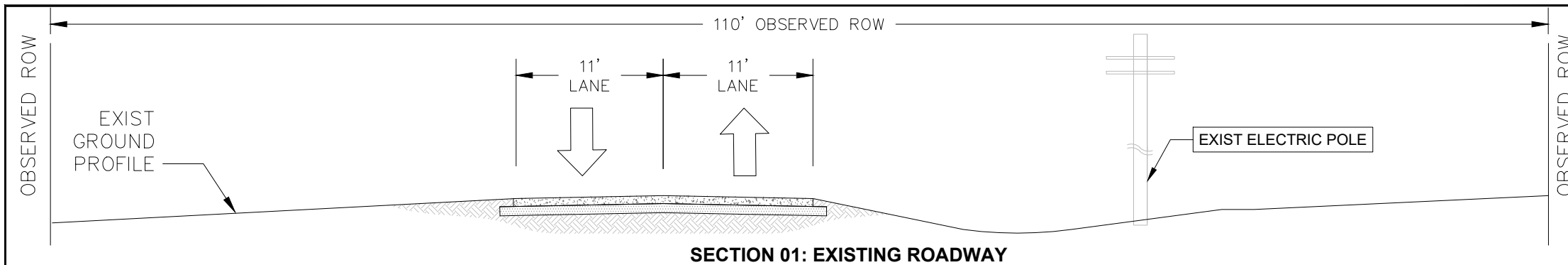

SECTION 01: EXISTING ROADWAY

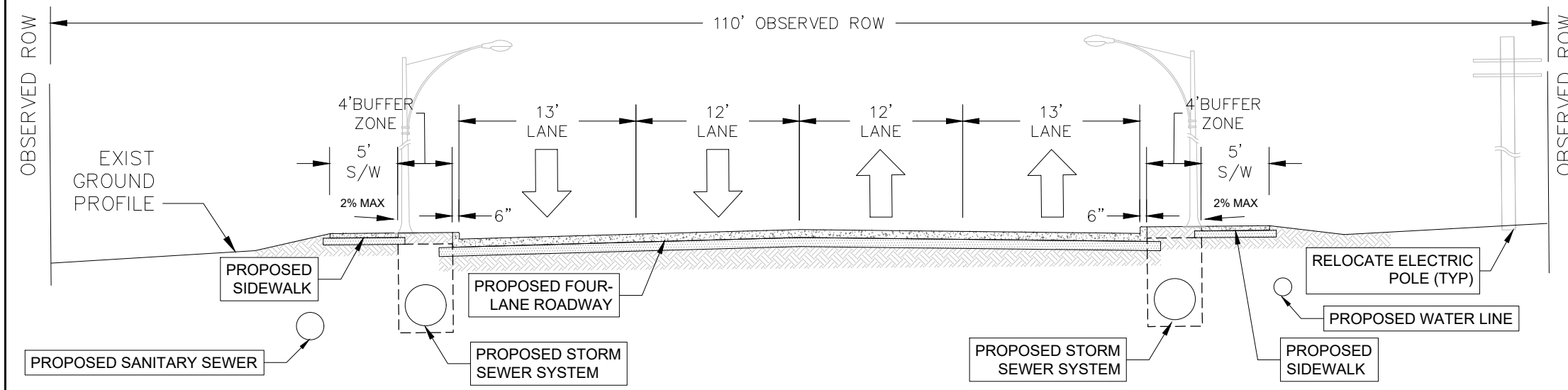

SECTION 01: PROPOSED ROADWAY IMPROVEMENTS

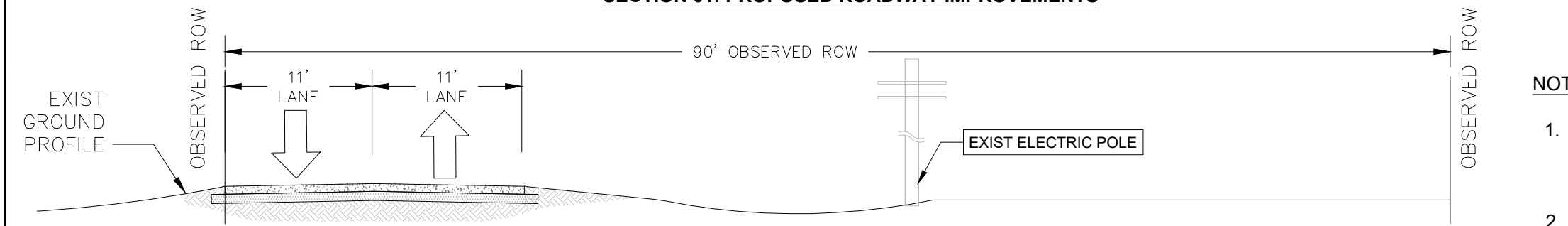

SECTION 02: EXISTING ROADWAY

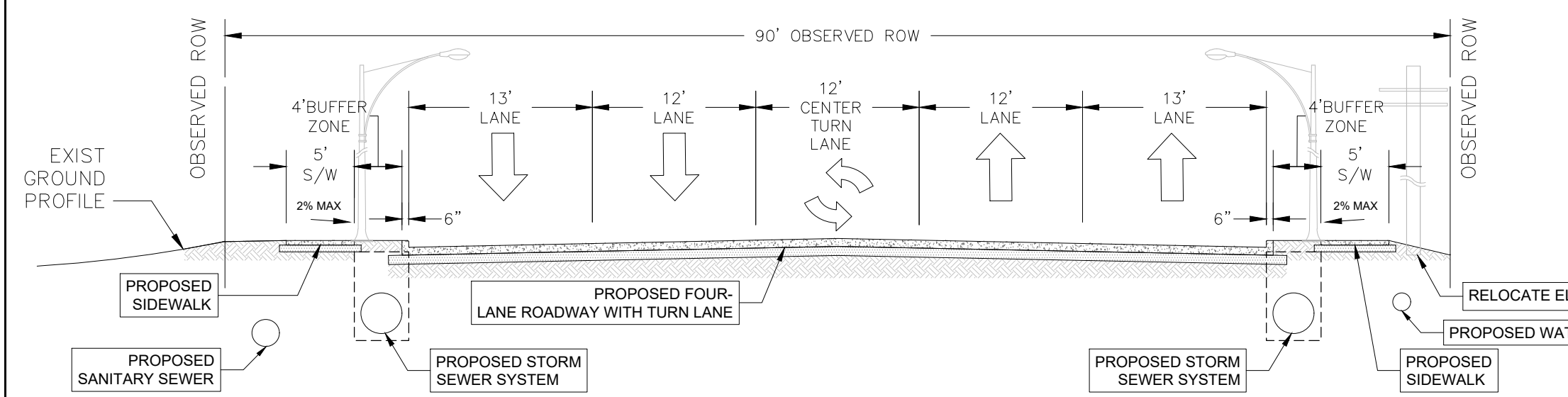

SECTION 02: PROPOSED ROADWAY IMPROVEMENTS

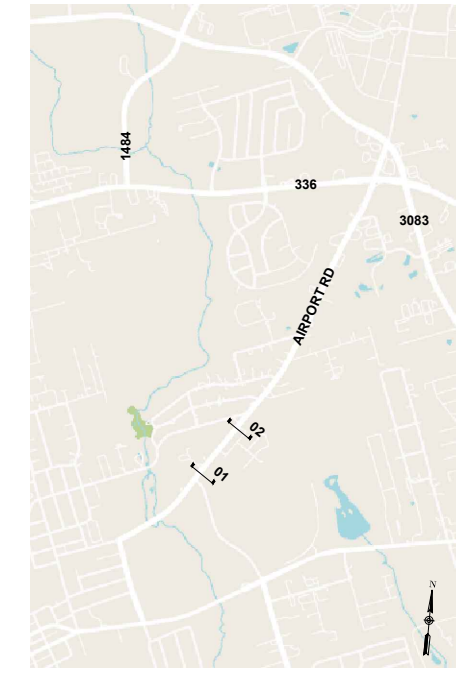

KEY MAP

NOTES:

1. R.O.W. INFORMATION IS BASED ON MONTGOMERY CAD DATA AND REQUIRES VERIFICATION BY THE SURVEYOR.
2. EXISTING GROUND PROFILE IS BASED ON INFORMATION AVAILABLE FROM GOOGLE EARTH AND NEEDS FURTHER VERIFICATION.

THE GOODMAN CORPORATION
 TBP&ES Firm Registration No. 19990
 3200 TRAVIS, SUITE 200
 HOUSTON, TEXAS 77006
 Phone: 713.951.7951

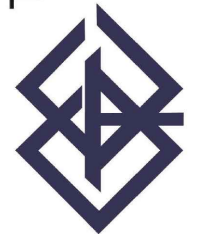

CITY OF CONROE
AIRPORT RD
IMPROVEMENT



ROAD WIDENING
 TYPICAL SECTIONS

EXHIBIT
 2 OF 2

SCALE: N.T.S. REV: B

DATE: 01/12/2022

DWG BY: BI

CHK BY: AG



Airport Road Reconstruction Project Development Report

Completed For:

City of Conroe, Texas



September 2022

Completed by:

THE **GOODMAN** CORPORATION



Contents

1. Project Introduction.....	1
2. Project Scope	2
3. Existing Conditions – Brief Overview.....	5
4. Project Purpose and Need.....	7
4.1 Project Purpose Statement.....	7
4.2 Project Needs.....	8
4.2.1 Upgrade Pavement Conditions and Increase Vehicular Capacity.....	8
4.2.2 Upgrade Drainage.....	9
4.2.3 Provide Safe Streets for All.....	10
4.2.4 Enhance Multimodal Connectivity	11
4.2.5 Connect Underserved Communities	11
Project Needs Summary	12
4.3 Advance Policy Goals	13
5. Project Cost.....	16
6. Project Benefit/Costs Analysis Summary	17
6.1 Benefits	20
6.1.1 Useful Life	20
6.1.2 State of Good Repair	20
6.1.3 Value of Time Travelled.....	20
6.1.4 Safety Benefits.....	20
6.1.5 New Pedestrian Users & VMT Reduced	20
6.1.6 Auto Costs.....	21
6.1.7 Environmental Benefits.....	21
6.1.8 Local Economic Benefits.....	22
7. Existing NEPA Status	23



List of Figures

Figure 1 Airport Road Project Limits.....	1
Figure 2 Airport Road Proposed Cross-section 01	2
Figure 3 Proposed Intersection of Airport Road and N Porter Road	2
Figure 4 Proposed Roadway Improvement at Airport Road and E Dallas St.	3
Figure 5 Airport Road Proposed Cross Section 02	3
Figure 6 Proposed Intersection of Airport Rd & N Loop 336 E	4
Figure 7 Proposed Intersection of Airport Rd & FM 3083 Rd	4
Figure 8 Existing Cross Section 01	5
Figure 9 Existing Cross Section 02	5
Figure 10 Guard Rails and Unpaved Shoulders on Airport Rd	6
Figure 11 Airport Rd and Loop 336 Intersection (L); and Airport Rd and FM 3083 Intersection (R).....	7
Figure 12 Airport Rd asphalt roadway with cracked pavements	9
Figure 13 Unpaved Shoulder and Guard Rails between E Dallas St and Venetian Pines. Dr.....	9
Figure 14 Water retention in ditches	9
Figure 15 Typical intersection on Airport Rd with no crosswalks	10

List of Tables

Table 1 Intersection Characteristics	6
Table 2 Airport Road Intersection LOS	8
Table 3 EJ/Equity Demographics	12
Table 4 Airport Road Reconstruction Project Cost.....	16
Table 5 BCA Summary.....	18
Table 6 Benefits Summary	19
Table 7 Environmental Review Summary	24



1. Project Introduction

The Airport Road Reconstruction Project will widen the road from two to four lanes and add pedestrian facilities on both sides of the project corridor. The project extends from N Porter Road to N FM 3083 Rd E on Airport Road. Airport Rd intersects with two major roadways, N Loop 336 E (Arterial) and N FM 3083 Rd E (Minor Arterial) at the northern limit of the project (Figure 1). Airport Road has also been referred to as FM 1483 Road.

The project corridor is 1.50 miles long. It is surrounded by mixed land uses - residential properties, Anderson Elementary School, a Home Depot Distribution Center, small businesses, civic centers, and institutions like Montgomery County Women’s Center and Little Texans Child Care Centers. These destinations are also the major trip generators around the project corridor and will benefit from the proposed Airport Road Reconstruction Project.

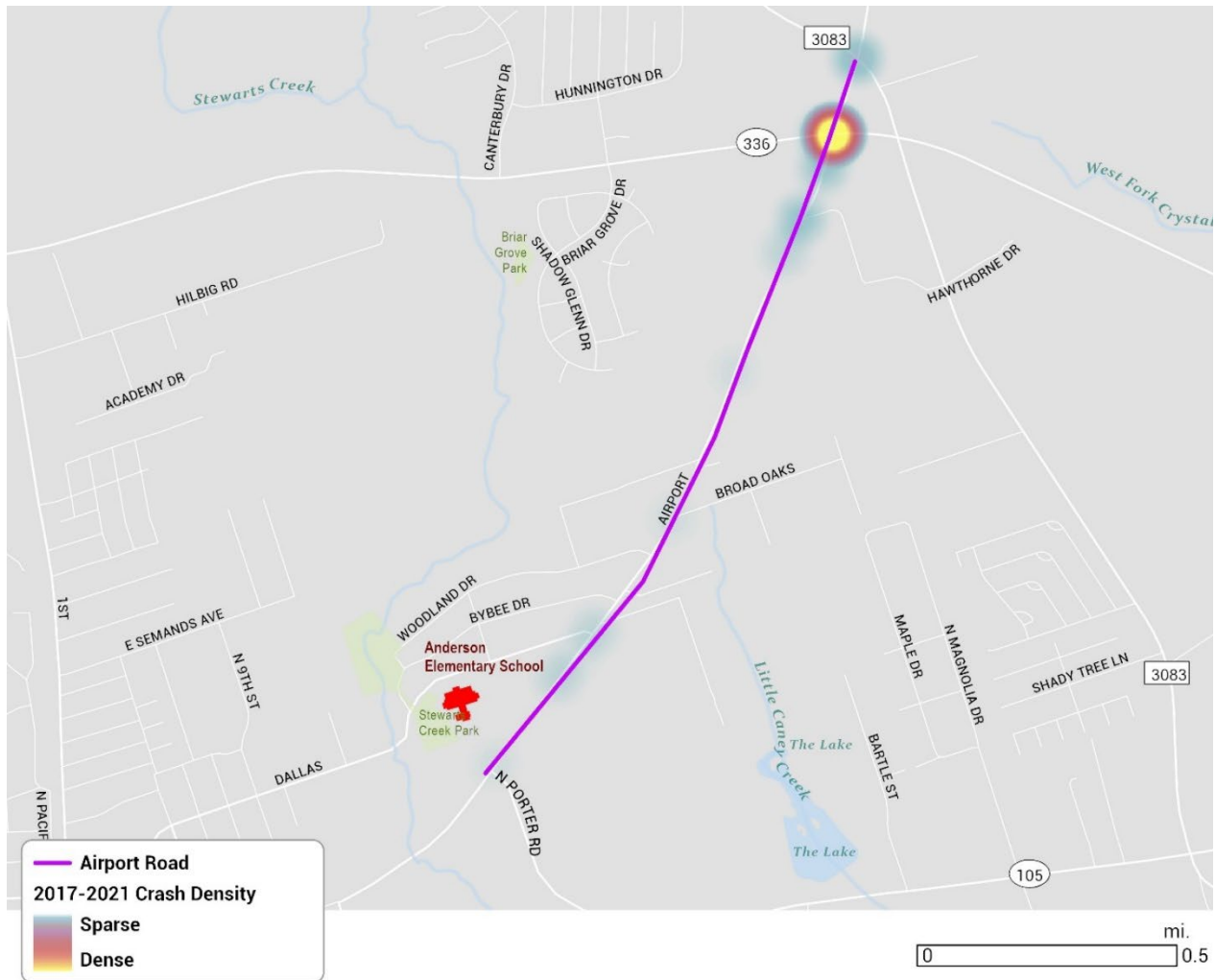

Figure 1 Airport Road Project Limits



2. Project Scope

The Airport Road Reconstruction Project proposes to widen the road from two lanes to four lanes and install 5-foot-wide sidewalks with ADA-compliant ramps and crosswalk markings on both sides of Airport Road from N Porter Road to N FM 3083 Rd E. Project limits are shown in Figure 1. Figure 2 illustrates the proposed cross-section. (Note: This cross-section of 4 travel lanes with a 5' sidewalk – measuring a total of 69' in width - is the most typical proposed cross-section for the project corridor.)

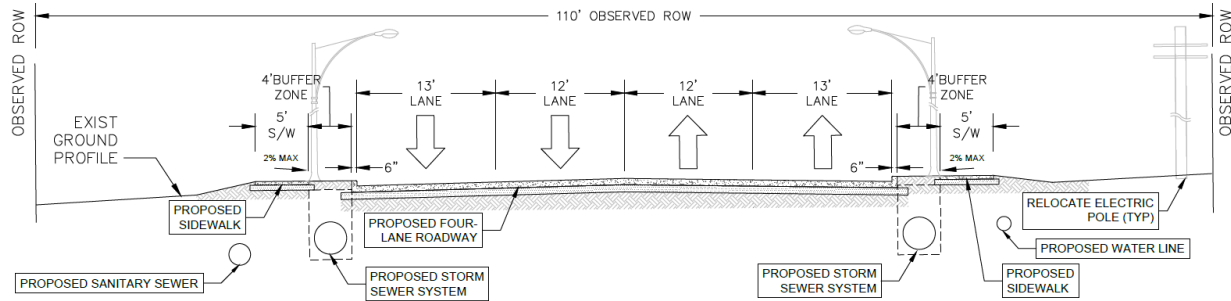

Figure 2 Airport Road Proposed Cross-section 01

Figure 3 illustrates the proposed intersection of Airport Rd and N Porter Road (intersection at the project’s southern limits). The available ROW at this section is 110’, and the widened cross-section measures 69’. Note that Airport Road beyond the southern project limit remains a two-lane corridor.

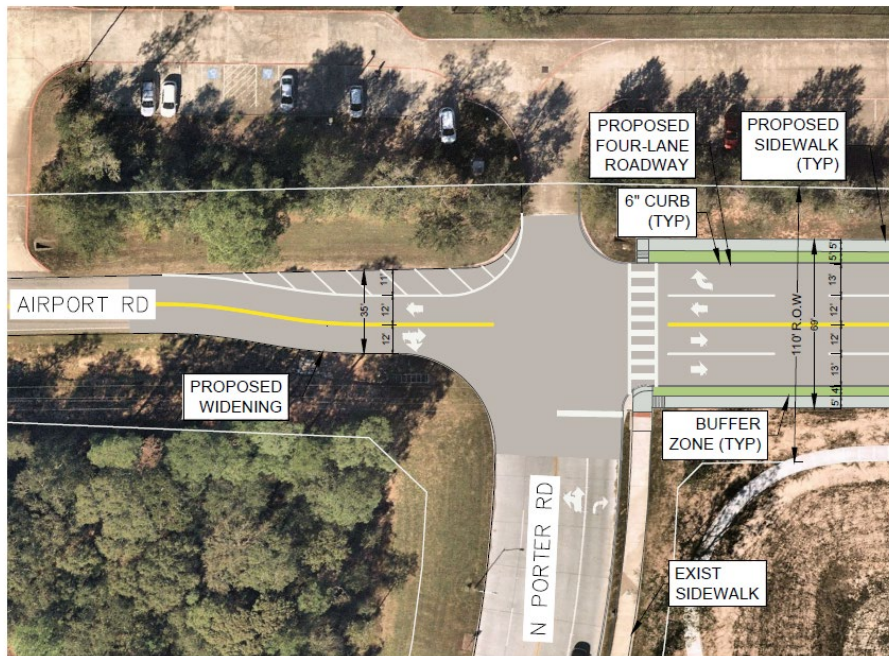

Figure 3 Proposed Intersection of Airport Road and N Porter Road

A 0.2-mile stretch on Airport Road between Venetian Pines Dr. and E Dallas St. has an existing 12-foot left-turn lane on the two-lane roadway, which provides access to the neighboring developments. On this stretch, the proposed widening will include a 4-lane roadway with a center two-way turn lane of 12’. The available ROW



varies between 80' to 90', and the cross-section utilizes 72' of the ROW. Figures 4 and 5 illustrate the proposed plan and cross-section, respectively.

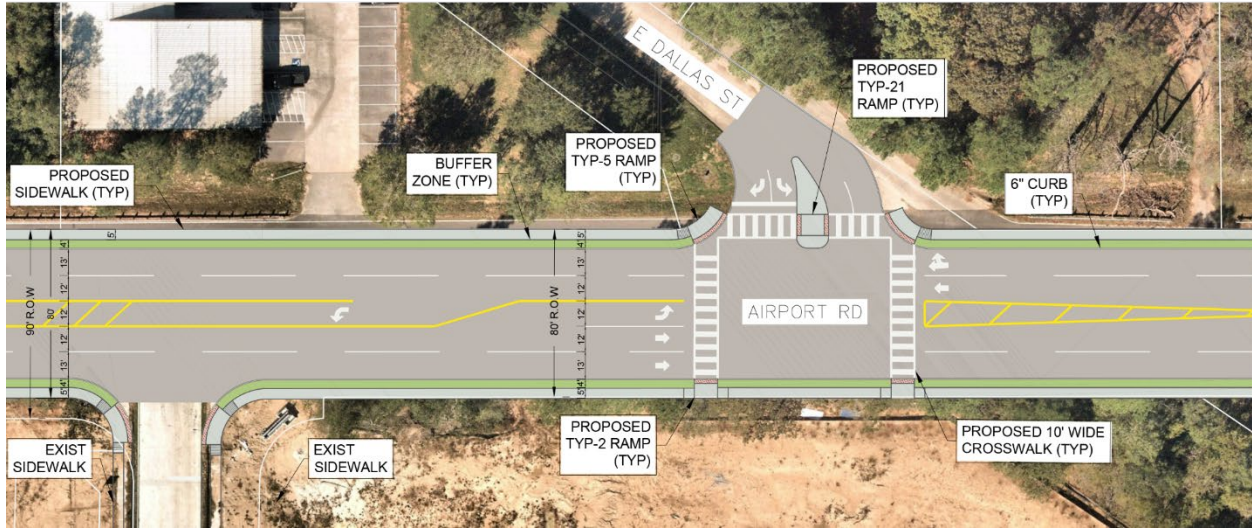

Figure 4 Proposed Roadway Improvement at Airport Road and E Dallas St.

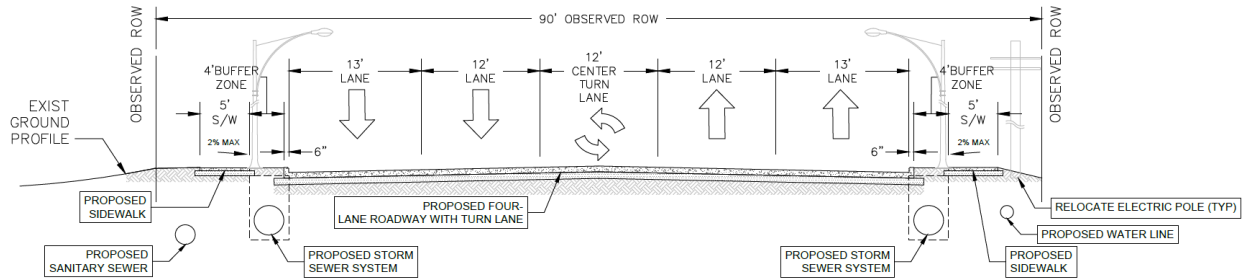

Figure 5 Airport Road Proposed Cross Section 02

The project will also upgrade two intersections of Airport Road with Loop 336 and FM 3083. The Loop 336 intersection upgrade will include: replacing the span wire signal with mast arms, lane widening (including the added turn lane), and adding median refuge islands (Figure 6). The FM 3083 intersection upgrade will include relocation of the newly mounted signal poles, lane widening (including a new right-turn lane) and adding



median refuge islands (Figure 7). These improvements will mitigate congestion, improve travel time, and improve safety.

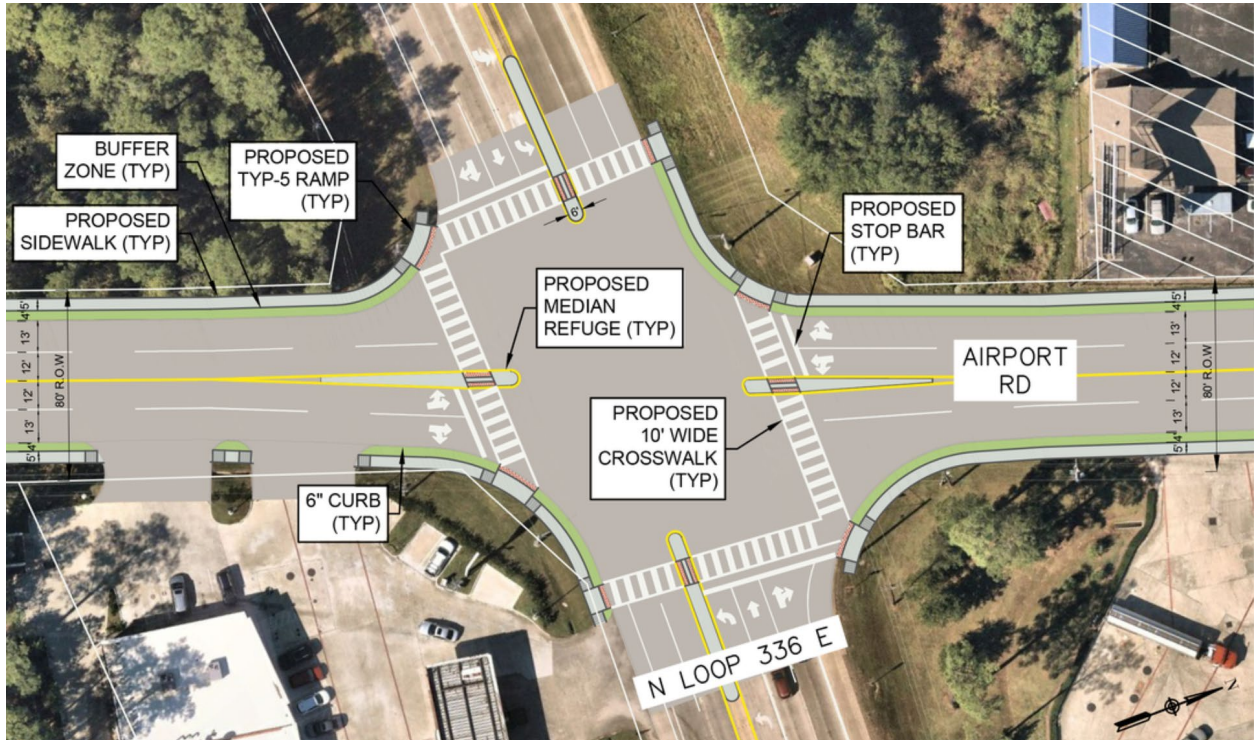

Figure 6 Proposed Intersection of Airport Rd & N Loop 336 E

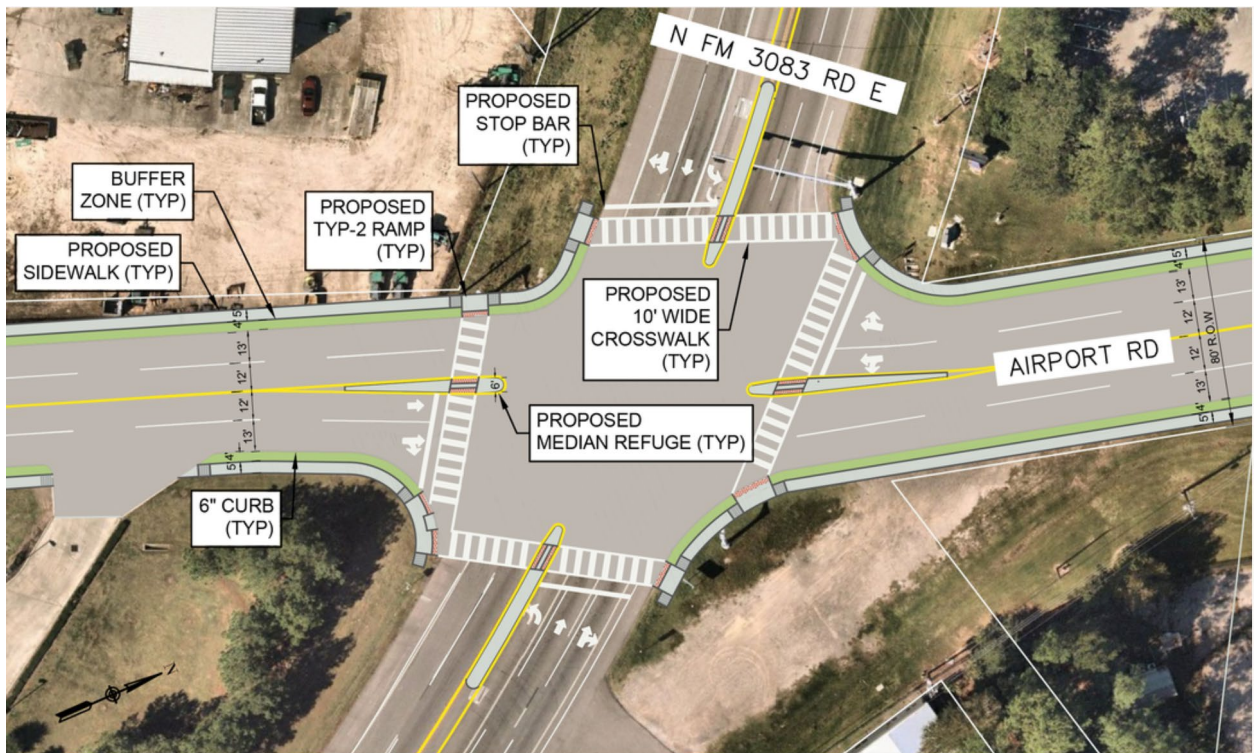

Figure 7 Proposed Intersection of Airport Rd & FM 3083 Rd



The proposed pavement design will utilize concrete panels. The drainage improvements include:

- Adding 24-inch reinforced concrete pipes (16,820 ft) for stormwater and 4’ by 4’ stormwater inlets
- Junction boxes
- Extending 4’ by 5’ box culverts.

Multimodal improvements include installing a 5’ wide sidewalk with ADA-compliant ramps and curb extensions and adding crosswalk markings. The project will also include the installation of additional street lighting. Water and sanitary sewer improvements were not considered in the development of this scope but may be relocated and/or upgraded as a component of the project and further reviewed at the detail design phase.

The proposed cross-section adheres to the City of Conroe’s minor arterial concrete street section standard details that specify a minimum right-of-way (ROW) of eighty feet (80’). The project corridor maintains a minimum ROW of 80’ throughout the project limits and does not require any acquisition.

3. Existing Conditions – Brief Overview

Airport Road, as it exists, is a two-lane, undivided asphalt roadway (Figure 8) except for a 0.2-mile segment between Venetian Pines Dr and E Dallas St, which has a 11-foot turn lane (Figure 9) to provide access to the neighboring developments. The ROW within project limits varies between 80’ to 110’. The travel lane is 11 feet wide in both directions, with no sidewalks or paved shoulders on either side.

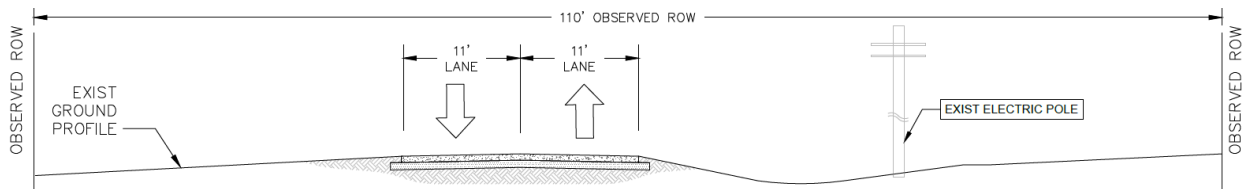

Figure 8 Existing Cross Section 01

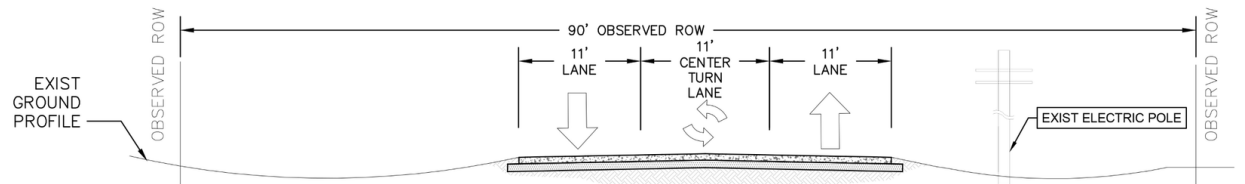

Figure 9 Existing Cross Section 02

Between E Dallas St and Venetian Pines Dr, the roadway has approximately 5 to 8 feet of unpaved shoulders, and guard rails are provided on the edge of the road for safety due to the steep slope (Figure 10). There are open drainage ditches along both sides of the road, with culvert crossings at the entrances. The roadway has faded pavement markings. There are no crosswalks along the corridor, even at the intersection of N Loop 336 E & N FM 3083 Rd E, making the route hazardous for pedestrians.



Figure 10 Guard Rails and Unpaved Shoulders on Airport Rd

Within the project limits, Airport Road intersects with five through streets, creating the three/four approach intersections. The following table summarizes the existing conditions of the intersections with key characteristics:

Table 1 Intersection Characteristics

Intersection Name	Traffic Control Mechanism	State of Good Repair	Lane Widths <i>(Airport Road and Intersecting St, respectively)</i>
Airport Rd. & Porter Rd./N 10 th St	NA	Good	2 lanes and 4 lanes
Airport Rd. & E Dallas St	Stop Controlled	Good	2 lanes (w. a center turn lane) and 2 lanes
Airport Rd. & FM 3083 E	Traffic Signal	Poor	2 lane and 5 lanes (2,2, and center turn-lane)
Airport Rd. & Loop 336 E	Traffic Signal (span wires)	Poor	2 lane and 5 lanes (2,2, and center turn-lane)



Of the four intersections in the project corridor, only two signals are signalized - Airport Rd. & FM 3083 E, and Airport Rd. & Loop 336 E. The intersection of Airport Rd & N Loop 336 E is regulated by span wire-mounted traffic lights, and the intersection of Airport Rd & N FM 3083 Rd E is controlled by traffic signals mounted on mast arms (Figure 11). Airport Rd & N Loop 336 E intersection has been identified as a hotspot for crashes as per TxDOT crash data 2017-21 (Figure 1). On the eastern side of Airport Rd, utility poles support overhead electric lines and telephone lines. Some of these utility poles also have streetlights. Around the intersections, streetlights are mounted independently.



Figure 11 Airport Rd and Loop 336 Intersection (L); and Airport Rd and FM 3083 Intersection (R)

4. Project Purpose and Need

Most funding and oversight agencies, including TxDOT, and the USDOT, require grantees to develop a project purpose and needs statement for grant application. The purpose of a project is considered the “what” of the project, outlining the project scope and elements that will be developed. The project need(s) addresses the “why” of the project, drawing out the unmet needs and societal benefits that the project will accomplish.

4.1 Project Purpose Statement

The project will reconstruct the Airport Road corridor from N Porter Road to N FM 3083 Rd E with four travel lanes, add a turn-lane (between Venetian Pines Dr. and E Dallas St.), and improve pedestrian amenities. This project will improve sidewalks, lighting, curb ramps, and crosswalks. It will replace the open ditches with a new covered drainage system to prevent non-point source pollution from open drainage systems.

Project Needs

- Upgrade Pavement Conditions and Capacity
- Upgrade Storm Water facilities
- Provide Safe Streets for All
- Enhance Multimodal Mobility
- Connect Underserved Communities



In summary, the Airport Road Reconstruction Project will provide all road users with a well-lit, safer, and more efficient corridor along with a safe and continuous pedestrian path serving neighboring households, institutions, schools, and businesses.

4.2 Project Needs

Airport Road is classified as a minor Arterial in the Conroe 2035 Thoroughfare Plan’s functional classification. Per Conroe’s 2035 Thoroughfare Plan, the recommended ROW for minor arterials is a minimum of 80’, and the existing field conditions comply with the recommendations.

The corridor functions as an essential north-south connection for Conroe, with the average annual daily traffic (AADT) for 2020 at 3,280. This daily traffic flow is projected to rise to 4,592 by 2040 as per TxDOT Statewide Map – which also classifies the corridor as a Minor Arterial. The existing speed limit is 55mph, and the 24-hour truck percentage is 7.8%, higher than other minor arterial roads in Conroe. The higher truck traffic might also be an outcome of the corridor’s proximity to Home Depot Distribution Center on N Porter Road.

The project needs were identified through a detailed analysis and are as follows:

- Pavement Conditions and Vehicular Capacity
- Upgrade Drainage
- Safety
- Multimodal Mobility
- Equity

The upcoming sections develop each need in detail:

4.2.1 Increase Vehicular Capacity and Upgrade Pavement Conditions

Large tracts of land abutting this corridor are vacant. Substantial sections of Airport Road are attracting new residential and commercial/industrial developments. Given this general direction of growth in Conroe and co-location manufacturing and warehousing businesses on Airport road - Home Depot Distribution Center being the largest facility of all - adding lanes to keep up with the future traffic needs will be necessary. The widening of N Porter Rd from SH 105 (E Davis St) to Airport Road, and additional new development on either side of Airport Rd, are expected to increase traffic volumes in this corridor. The intersection of Airport Rd. & Loop 336 E with its current configuration, will operate at LOS E in PM peak hour of year 2045 and will have considerable delay. HCM analysis in Synchro shows that the proposed reconstruction with four lanes will improve the traffic operations at this intersection to LOS D for the same period (Table 2).

Table 2 Airport Road Intersection LOS

Intersection Name	No Build LOS				Fully Build LOS			
	AM		PM		AM		PM	
	2025	2045	2025	2045	2025	2045	2025	2045
Airport Rd. & FM 3083 E	C	C	C	D	C	C	C	C
Airport Rd. & Loop 336 E	B	D	B	E	B	C	B	D



Figure 12 Airport Rd asphalt roadway with cracked pavements

The City endeavors to maintain growth and development by building sufficient vehicular capacity and providing pedestrian-friendly mobility opportunities to meet the transportation needs of people of all ages while also improving the overall quality of life and neighborhood characteristics. Airport Road does not meet these standards currently.

The existing asphalt roadway is generally in a good state of repair, although some segments have developed cracks and faded pavement markings (Figure 12). Significant pavement damage exists on the corridor between Loop 336 and FM 3083. The corridor has unpaved shoulders and lacks a sidewalk and curbs. Between E Dallas St and Venetian Pines. Dr, the roadway has approximately 5 to 8 feet of unpaved shoulders, and guard rails are provided on the edge of the road for safety due to the steep slope.



Figure 13 Unpaved Shoulder and Guard Rails between E Dallas St and Venetian Pines. Dr

4.2.2 Upgrade Drainage

The project corridor is not within a floodplain. There are open drainage ditches along both sides of the road, with culvert crossings at the entrances. Post rainfall events, most drainage ditches retain standing water and can be a collection point for litter and debris(Figure 14).



Figure 14 Water retention in ditches



4.2.3 Provide Safe Streets for All

All levels of government need to create safe streets for all. For the State of Texas, traffic fatalities are a major concern. TxDOT is developing and implementing solutions to reduce the number of deaths on Texas highways by half in 2035 and to zero in 2050.¹

The Highway Safety Improvement Program (HSIP) is a core Federal-aid program with the purpose to achieve a significant reduction in traffic fatalities and serious injuries on all public roads. Over the years, HSIP has compiled effective resources and design-directives for crash reduction for roads of all functional classifications. From 2017 to 2021, a total of 100 crashes occurred along this corridor. On basis of HSIP’s empirical studies and guidance, 8 of these crashes could have been reduced by 28% if there was a dedicated turn-lane. 23 of these crashes do not qualify for a crash reduction factor basis HSIP guidance. There have been no pedestrian-related injuries on this corridor as per the TxDOT crash data. According to HSIP countermeasures, a continuous left turn lane would reduce most turning movement crashes by 50% and modernizing the intersections will reduce intersection-related crashes by 24%². A sidewalk combined with lighting would reduce pedestrian and nighttime auto-related crashes by 74%³. This Project includes all these elements in its scope and will reduce the likelihood of pedestrian-and vehicle-related crashes, which creates a safer street for all users.



Figure 15 Typical intersection on Airport Rd with no crosswalks

Based on the statistical value of life and the severity of the injuries sustained, the total economic cost of the crashes from 2017-2021 was \$6.9 million, averaging about \$1.3 million per year. Additionally, the average 5-year crash rate in the Project corridor is 345 crashes per 100 million vehicle miles traveled - 60% more than the TxDOT statewide average of 215 crashes per 100 million vehicle miles⁴. These statistics call out Airport Road as an unsafe corridor.

¹ TxDOT Vision Zero . Retrieved from <https://ftp.txdot.gov/pub/txdot-info/cst/conference/washto-wyer.pdf>

² TxDOT. Highway Safety Improvement Manual, 2020. Retrieved August 2021 from <https://www.txdot.gov/inside-txdot/forms-publications/publications/highway-safety.html>

³ TxDOT. Highway Safety Improvement Manual, 2020. Retrieved August 2021 from <https://www.txdot.gov/inside-txdot/forms-publications/publications/highway-safety.html>

⁴ Texas Motor Vehicle Crash Statistics - 2020. (2020). TxDOT. <https://www.txdot.gov/inside-txdot/forms-publications/drivers-vehicles/publications/annual-summary.html>



4.2.4 Enhance Multimodal Connectivity

According to the 2017 FHWA NHTS (National Household Travel Survey), over 65% of respondents indicated that they do not walk more because there are no sidewalks or sidewalks in poor condition. Over 35% told they don't feel safe walking due to heavy traffic volumes.⁵ Most people will not walk on high-volume streets with sidewalks in poor condition. Airport Rd is dominated by vehicular traffic and has no sidewalks. Integrating pedestrian pathways complete with ADA ramps and crosswalks will improve multimodal connectivity with current and future land uses (residential and institutional) conducive to robust pedestrian activity. Building seamless, safe, and accessible paths along this roadway will enhance multimodal mobility, providing various benefits (see Project BCA Summary).

4.2.4.1 Conroe Connection Transit

Conroe Connection Transit (CCT) has a transit stop along N Loop 336 E at the Texas Department of Assistive & Rehab Services, serving on its Northeast Route. This stop is about half a mile from the project corridor (intersection of Airport Road and Loop 336). This route serves key destinations like Lonestar College Conroe Center, Texas Health and Human Services, Department of Family and Protective Services, and Conroe Downtown. This route is served every 60 min on weekdays. The Airport Road Reconstruction project will install sidewalks along the project corridor, thereby enhancing the pedestrian shed along the project corridor to access Conroe's transit.

4.2.4.2 Connectivity to Regional Trails

The project corridor is half a mile away from Stewarts Creek Park (a utility easement Trail) that feeds into the Carter Moore Trail regional trail system⁶, which is being planned as a key scenic route with recreational opportunities. Installing sidewalks along the Project corridor will open up safe and accessible regional recreational opportunities for the corridor/neighborhood residents.

4.2.5 Connect Underserved Communities

This Project will safely connect the growing community to the airport, retail, commercial, education, and restaurants. Transportation options have a significant impact on community residents' quality of life. Those with lower incomes are less likely to own cars and may not live in areas well served by high-quality transportation assets and thereby experience more difficult trips to access schooling, employment, and other critical needs. These inferior transportation outcomes result from decades of inequitable auto-oriented planning. The Biden administration is committed to mitigating these outcomes by furthering equitable and inclusive policies and programs. To this effect, some of the initiatives that the administration is pushing are *safer and smart streets*, *bringing greater transparency to USDOT grant programs*, *investing in inner-city transit*, and *an emphasis on policies that leverage land-use components to deliver more innovative mobility options to residents*. While these initiatives have an integral equity and sustainability component, the

⁵ Federal Highway Administration. National Household Survey 2017. Retrieved in August 2021 from <https://nhts.ornl.gov/>

⁶ Conroe Parks and Recreation Master Plan 2009. Page 44. Retrieved from <https://www.cityofconroe.org/home/showpublisheddocument/3062/635295332251400000>



discretionary dollars disbursed under these programs have performance indicators that evaluate the application’s basis equity as a prioritized theme.

This Project will improve an essential north-south connection in northeast Conroe. The corridor hosts diverse land uses, of which the top three categories are residential, multiple, and vacant (including farming). Within 500 feet of the project corridor, the population demographics show that indicators generally associated with underserved communities like households below the poverty level, the share of the population of color, and households with less than high school education are significantly higher in the project area than its regional counterparts. Selected demographics for the Project corridor are presented below:

Table 3 EJ/Equity Demographics

EJ and Equity Demographics ⁷				
Demographic	Project Area	City of Conroe	Montgomery County	Houston-The Woodlands-Sugar Land, TX MSA
2020 Total Population	366	94,469	649,403	7.2M
2020 Population Density (pop per sq. mi.)	977.6	1,313	623	875
2019 Households Below the Poverty Level (%)	12.73%	10.83%	8.72%	12.66%
2019: People of Color Population (%)	25.84%	17.01%	13.55%	34.97%
2020: Less Than HS Education (%)	30.47%	17.36%	11.14%	7.34%
2019: Households with No Vehicles (%)	1.87%	4.79%	2.92%	4.88%
2019 Households with 1+ Persons with a Disability (%)	26.36%	21.10%	21.60%	20.74%

Thus, this project will improve underserved community’s access to multimodal transportation to meet their daily travel needs.

Project Needs Summary

The project needs for Airport Road corridor can be summarized as follows:

Substantial sections of Airport Road are attracting new residential and commercial/industrial development. The corridor's existing capacity is expected to be insufficient to handle the future vehicular volume. There are no sidewalks on this corridor. It lacks safe, continuous, accessible pedestrian paths. Open ditches are contributing towards non-point source pollution in the area watershed. The corridor has experienced 100 crashes in the past five years. The average 5-year crash rate is 60% more than the TxDOT statewide average. The project corridor has a higher share of underserved communities compared to the regional average (21%).

The Airport Road Reconstruction Project addresses these needs by providing all road users with a well-lit, safer, and more efficient corridor along with a safe and continuous pedestrian path serving neighboring households, institutions, schools, and businesses.

⁷ ARCGIS. Business Analyst. Retrieve in May 2021.



Planning literature^{8 9} demonstrates that adding accessible pedestrian facilities can increase property values and make the neighborhood more livable, resulting in increased appraisal values that provide additional property tax benefits to the corridor/neighborhood. This way, reconstructing a roadway with pedestrian facilities can be seen as a value capture tool that will catalyze economic development. Airport Road Reconstruction is an investment to spur equitable economic development in Northeast Conroe, which will attract competitive businesses to co-locate along the Airport Road, making it prosper as a mixed-use corridor.

4.3 Advance Policy Goals

The data presented in the above sections justify the Project through technical analysis. The Project advances various safety, connectivity, equity, economic, environmental, and other related policies rooted within the national, state, regional, and local transportation agencies' objectives, goals, mission, and/or vision.

National Transportation Policy and Planning

The United States Department of Transportation provides the leadership and sets the framework for transportation goals and objectives of the United States. These strategically developed goals permeate the state, regional and local transportation planning. The USDOT has adopted the following four goals within its USDOT Strategic Plan FY 2018-2022:¹⁰

- **Safety:** Reduce Transportation-Related Fatalities and Serious Injuries Across the Transportation System.
- **Infrastructure:** Invest in Infrastructure to Ensure Mobility and Accessibility and to Stimulate Economic Growth, Productivity and Competitiveness for American Workers and Businesses.
- **Innovation:** Lead in the Development and Deployment of Innovative Practices and Technologies that Improve the Safety and Performance of the Nation's Transportation System.
- **Accountability:** Serve the Nation with Reduced Regulatory Burden and Greater Efficiency, Effectiveness and Accountability.

In addition to the goals above, President Biden has publicly supported the Safe Streets for All program. This program is aimed at investing in infrastructure that reduces crashes and fatalities for all street users, specifically pedestrian and bicycle.¹¹ As of August 2021, this program has not been signed into law nor funded but has received support by a number of US Senators and House members. In addition, President Biden issued EO 13985, Advancing Racial Equity and Support for Underserved Communities Through the Federal Government on January 20th, 2021. EO 13985 directs the Office of Management and Budget to: *in coordination with the heads of agencies, study strategies, consistent with applicable law, for allocating Federal resources in*

⁸ Liu, J. H., & Shi, W. (2017). Impact of bike facilities on residential property prices. *Transportation research record*, 2662(1), 50-58.

⁹ The University of Delaware. Healthy and complete communities in Delaware: The walkability assessment tool. Retrieved in June 2017, from <http://www.ipa.udel.edu/healthyDEtoolkit/walkability/benefits.html>.

¹⁰ United States Department of Transportation. DOT Strategic Plan Fiscal Years 2018-2022. Retrieved in April 2020 from <https://www.transportation.gov/dot-strategic-plan>.

¹¹ The White House. UPDATED FACT SHEET: Bipartisan Infrastructure and Investment Jobs Act. Retrieved in August 2021 from <https://www.whitehouse.gov/briefing-room/statements-releases/2021/08/02/updated-fact-sheet-bipartisan-infrastructure-and-investment-jobs-act/>.



*a manner that increases investment in underserved communities, as well as individuals from those communities.*¹²

The Airport Road Reconstruction advances USDOT’s policy goals by improving safety, and multimodal transportation choices, especially for underserved communities. Basis the HSIP directives, the design scope includes all elements that would reduce the likelihood of pedestrian and vehicular crashes, like – left turn lanes, modernizing intersections, a sidewalk combined with street lighting, and pedestrian median refuges. The project demographics around 500 feet from the project corridor highlight the higher share of underserved communities compared to the regional averages. Delivering the proposed project will improve safe and equitable transportation outcomes in Conroe.

State Transportation Policy and Planning

The TxDOT 2019-2023 Strategic Plan (TxDOT Plan) is the plan that will guide the agency over the next several years.¹³ Included in the TxDOT Plan is the agency’s mission, values, vision, goals and action plan and budgetary structure. The TxDOT Plan outlines seven strategic goals that are rooted in the Mission and Vision.

- **Mission** - Through collaboration and leadership, we deliver a safe, reliable, and integrated transportation system that enables the movement of people and goods.
- **Vision** - A forward-thinking leader delivering mobility, enabling economic opportunity, and enhancing quality of life for all Texans.

In May 2019, the TxDOT Transportation Commission issued MO 115481. This MO directs TxDOT to reduce to traffic fatalities in half by 2035 and end them entirely by 2050, which is statewide Vision Zero policy. To further support this Vision Zero policy, TxDOT’s PLAN2050 outlines six goals, with corresponding objectives. One of the goals is to promote safety by reducing *crashes and lessen crash severity by implementing engineering solutions*.¹⁴

The project responds to the goals by integrating HSIP’s design directives in its scope: the introduction of left turn lanes, modernizing intersections, adding sidewalks with street lighting, and introducing median pedestrian refuges at busy wide intersections, improving traffic safety. It is worth noting that the average 5-year crash rate in the Project corridor is 345 crashes per 100 million vehicle miles traveled - 60% more than the TxDOT statewide average of 215 crashes per 100 million vehicle miles¹⁵- qualifying the corridor to become a priority project advancing State’s Vision Zero policy.

¹² 86 FR 7009. Executive Order 13985, Advancing Racial Equity and Support for Underserved Communities Through the Federal Government.

¹³ Texas Department of Transportation. 2019-2023 Strategic Plan. Retrieved in August 2021 from <http://ftp.dot.state.tx.us/pub/txdot-info/sla/strategic-plan-2019-2023.pdf>.

¹⁴ TxDOT. What Are Our Goals? Retrieved in August 2021 from <https://www.txdot.gov/inside-txdot/division/transportation-planning/statewide-plan/goals.html>.

¹⁵ Texas Motor Vehicle Crash Statistics - 2020. (2020). TxDOT. <https://www.txdot.gov/inside-txdot/forms-publications/drivers-vehicles/publications/annual-summary.html>



Regional Transportation Policy and Planning

The H-GAC 2040 Regional Transportation Plan vision statement includes supporting project that increase safety, access, and mobility. This vision statement is further grounded in goals and strategies. One of the four strategies is to expand the multimodal network, which further aligns with the Project outcomes.¹⁶

In addition to the H-GAC 2040 Regional Transportation Plan, H-GAC recently completed a H-GAC 2045 Regional Active Transportation Plan. The H-GAC 2045 Regional Active Transportation Plan set forth a vision: In the year 2045, our region will have a multimodal transportation system through coordinated investments that supports a desirable quality of life, enhanced economic vitality and increased safety, access and mobility. This vision is supported by the goals of prioritizing safety, ensuring equity, connecting (areas of high-need), maintaining, monitoring, and encouraging use of active transportation modes.¹⁷

As described in Section 4.2.4 Enhance Multimodal Connectivity, the Airport Road Reconstruction Project will install sidewalks along the project corridor and improve the pedestrian network accessing Conroe Connection Transit- This enhances access to affordable transportation options especially for the underserved communities living around the corridor. The project will also improve access to Stewarts Creek Park (a utility easement Trail) that feeds into the Carter Moore Trail regional trail system promoting active forms of transportation like cycling and walking for travel and recreational needs. Therefore, delivering the proposed project will advance the HGAC's objectives of expanding the multimodal network, local access, and mobility.

Local Transportation Policy and Planning

City of Conroe Comprehensive Plan 2040

Conroe's Comprehensive Plan envisions Conroe as a "...community of choice in the Houston metro area with a diversity of housing options in neighborhoods that are walkable and connected." The Plan's top guiding principle is to prioritize efforts and incentives to ensure adequate infrastructure within the City to support and attract existing and new developments. The Plan identified Airport as one of the four key areas under Major Opportunity Areas that present major opportunities for development and growth. The Plan also ranks the intersections on Airport Road, which suffers more than 25 crashes a year and has been recommended for safety improvements/upgrades in the near term. The proposed Airport Road reconstruction project is consistent with the priorities and implementation directives in the Comprehensive Plan.

¹⁶ H-GAC. H-GAC 2040 Regional Transportation Plan. Retrieved in August 2021 from <https://www.h-gac.com/getmedia/b6dc64b9-f5ea-4e7e-b708-38f64d15eccd/2040-RTP-revised-April-2016.pdf>

¹⁷ H-GAC. H-GAC 2045 Active Transportation Plan. Retrieved in August 2021 from <http://2045rtp.com/documents/plan/Appendix-H-Regional-Active-Transportation-Plan.pdf>



5. Project Cost

The total cost for the project is approximately **\$21.56 million**.

Table 4 Airport Road Reconstruction Project Cost

Item No.	Item Description	Unit	Qty	Unit Cost	Total
General Items					
1	Tree Protection	LS	1	\$ 11,250	\$ 11,250
2	Arborists	LS	1	\$ 7,500	\$ 7,500
3	Furnishing And Placing Topsoil (4")	SY	7,510	\$ 4	\$ 30,040
4	Block Sodding	SY	7,510	\$ 5	\$ 37,550
5	Tree Removal (24" - 30" Dia)	EA	17	\$ 1,500	\$ 25,500
6	Clearing And Grubbing	AC	9.00	\$ 10,000	\$ 90,000
7	Landscaping	SY	7,510	\$ 10	\$ 75,100
General Items Subtotal					\$ 276,900
Roadway					
1	Removing Conc (Driveways)	SY	3,789	\$ 20	\$ 75,772
2	Removing Conc (Sidewalk Or Ramp)	SY	3	\$ 15	\$ 45
3	Removing Conc (Medians)	SY	60	\$ 25	\$ 1,500
4	Conc Curb & Gutter (Ty II)	LF	16,820	\$ 20	\$ 336,400
5	Removing Stab Base & Asph Pav (12")	SY	23,361	\$ 41	\$ 957,805
6	Excavation (Roadway And Channel)	CY	17,900	\$ 40	\$ 716,000
7	Driveways (Conc)	SY	3,790	\$ 85	\$ 322,150
8	Conc Sidewalks (5")	SY	9,344	\$ 70	\$ 654,110
9	Curb Ramps (Ty 1)	EA	1	\$ 2,000	\$ 2,000
10	Curb Ramps (Ty 2)	EA	2	\$ 2,500	\$ 5,000
11	Curb Ramps (Ty 5)	EA	14	\$ 3,000	\$ 42,000
12	Curb Ramps (Ty 7)	EA	31	\$ 2,500	\$ 77,500
13	Pav Surf Prep For Mrk (24")	LF	444	\$ 1	\$ 444
14	Refl Pav Mrk Ty I (W)24"(Sld)(100mil)	LF	444	\$ 7	\$ 3,108
15	Pavement Sealer 24"	LF	444	\$ 1	\$ 444
16	Refl Pav Mrk Ty I (Y)4"(Brk)(100mil)	LF	8,410	\$ 1	\$ 8,410
17	Refl Pav Mrk Ty I (Y)4"(Sld)(100mil)	LF	8,410	\$ 2	\$ 16,820
18	Raised Reflective Buttons	EA	430	\$ 20	\$ 8,600
19	Cement Treat (Subgrade) (8")	SY	46,722	\$ 8	\$ 373,777
20	Conc Pav (Joint Reinf) (10")	SY	46,722	\$ 100	\$ 4,672,218
21	Install Roadway Base	CY	8,915	\$ 120	\$ 1,069,752
22	Backfill (Ty A Or B)	CY	16,820	\$ 20	\$ 336,400
23	Upgrade Existing Traffic Signal To Mast Arm Etc.	LS	1	\$ 5,00,000	\$ 500,000
General Items Subtotal					\$ 10,180,300



Item No.	Item Description	Unit	Qty	Unit Cost	Total
Drainage					
1	RC Pipe (CI III)(24 In)	LF	16,820	\$ 90	\$ 1,513,800
2	Inlet (Compl)(PSL)(RC)(4ftx4ft)	EA	44	\$ 6,000	\$ 264,000
3	Junction Box (Install)	EA	35	\$ 1,000	\$ 35,000
4	Remove Str (Box Culvert)	EA	83	\$ 2,970	\$ 246,510
5	Conc Box Culvert (4 Ft X 5 Ft)(Extend)	LF	13	\$ 1,130	\$ 14,690
6	Remove Metal Beam Guard Fence	LF	2,687	\$ 10	\$ 26,870
Drainage Items Subtotal					\$ 2,100,900
Cash Allowance					
1	Permits	LS	1	\$ 3,000	\$ 3,000
2	TDLR Registration/Review/Inspection	LS	1	\$ 10,000	\$ 10,000
3	Install Lights	EA	44	\$ 2,800	\$ 123,200
4	Removal Of Timber Poles	EA	129	\$ 610	\$ 78,690
5	Timber Pole (CI 2) 30 Ft	EA	173	\$ 1,860	\$ 321,780
6	Relocate SM Rd Sn SUP & AM Ty 10bwg	EA	35	\$ 400	\$ 14,000
7	Adjusting Manholes	EA	31	\$ 450	\$ 13,950
8	Adjusting Manholes (Electric Box)	EA	31	\$ 1,200	\$ 37,200
9	Adjusting Manholes (Telephone Box)	EA	22	\$ 3,500	\$ 77,000
10	Remove And Relocate Fire Hydrant	EA	12	\$ 10,000	\$ 120,000
11	Adjusting Manholes (Water Valve Box)	EA	9	\$ 400	\$ 3,600
12	Relocate Existing Mailbox	EA	36	\$ 510	\$ 18,360
Cash Allowance Subtotal					\$ 820,800
Subtotal					\$ 13,378,900
Contingency (15%)					\$ 2,006,900
Mobilization (10%)					\$ 1,337,900
SWPP & Traffic Control (5%)					\$ 669,000
Total Construction Cost					\$ 17,392,700
Construction Management (2%)					\$ 347,900
Material Testing (1%)					\$ 174,000
Inspections & Quality Control (2%)					\$ 347,900
Total Construction Soft Cost					\$ 869,800
Environmental (2%)					\$ 347,900
Survey (2%)					\$ 347,900
Engineering PS&E (15%)					\$ 2,609,000
Total Engineering And Environmental Cost					\$ 3,304,800
TOTAL PROJECT COST					\$ 21,567,300



6. Project Benefit/Costs Analysis Summary

A BCA was conducted on this Project, which quantifies the net difference between the No-Build and Build Scenarios. The No-Build Scenario assumes that roadway improvements will only consist of mill and overlay or deteriorate over time. There are no planned sidewalks within the No-Build Scenario. The build scenario assumes a replacement of infrastructure within public ROW along the project limits, which will include the following major components:

- Expand lanes from 2 lanes to 4 lanes
- Upgrading the two intersections (Loop 336 and FM 3083) which includes:
 - replacing the mast arms (Loop 336)/relocation of the signal poles (FM 3083),
 - lane widening (including turn lane) -both intersections
 - adding median refuge islands – both intersections
- Add new 5 feet with ADA-compliant ramps and crosswalks
- Reconstruct the roadway in concrete.
- Install curb and gutter using 24 inches of reinforced concrete pipe along the corridor.

The societal benefits are grouped into sections based upon the latest RAISE discretionary grant criteria. Each benefit’s baseline (No-Build) and Build methodology and calculations are contained within this technical memorandum, supported by the BCA Excel Workbook. The benefits are quantified and monetized for the BCA. The benefit-cost ratio is 1.0 in 2019 real dollars, and when discounted at a 7% discount rate, the benefit-cost ratio is 0.3.

Table 5 BCA Summary

BCA Summary		
Scenario	\$2019 Real Dollars No Discount	\$2019 Real Dollars 7% Discount
Benefits	\$21,011,000	\$4,984,000
Costs	\$20,199,000	\$14,246,000
BCA	1.0	0.3

A technical memorandum explaining the methodology is attached in Appendix A: Airport Road Reconstruction Project Cost Benefit Analysis. A summary of the benefits is provided in the following table.



Benefits Summary

Benefit	Current Status/Baseline and Problem to be Addressed	Change to Baseline or Alternatives	Types of Impacts	\$2019 Monetized Benefit	7% Discount Rate
Benefit 1: Useful Life	The current asset has 90% remaining useful life	Replace infrastructures within public ROW	Extend useful life	\$10,245,000	\$1,764,000
Benefit 2: State of Good Repair	Ongoing expensive maintenance	Very Little maintenance required of new facility through the planning horizon	Maintenance cost savings	\$1,450,000	\$451,000
Benefit 3: Value of Time	Outdated intersection designs	Convert signals to mast arms and expand capacity	Travel time decrease	\$5,553,000	\$1,270,000
Benefit 4: Safety Benefits	Outdated design, disproportionately higher crash rates	Significant safety improvement resulting in 24% to 28% reduction in certain types of vehicle crashes.	Reduced crashes resulting in reduced fatalities and injuries	\$2,131,000	\$1,019,000
Benefit 5: Pedestrian Reduced Auto Use Benefits	Roadway is not conducive for walking.	Sidewalks will induce pedestrian demand	Reduced auto cost benefits derived from modal shift from auto to walk	\$380,000	\$121,000
Benefit 6: Automobile Fuel Benefits	Outdated intersection designs	Improve traffic throughput at intersections	Reduced fuel cost derived from reduced idling	\$919,000	\$259,000
Benefit 7: Environmental Benefits	Roadway is not conducive for walking.	Sidewalks will induce pedestrian demand	Reduced auto cost benefits derived from modal shift from auto to walk	\$19,000	\$11,000
Benefit 8: Automobile Idling Environmental Benefits	Outdated intersection designs	Improve traffic throughput at intersections	Reduced emissions cost derived from reduced idling	\$314,000	\$89,000
Totals				\$21,011,000	\$4,984,000

Table 6 Benefits Summary



6.1 Benefits

6.1.1 Useful Life

The corridor will have a useful life of 50 years. Therefore, at the end of the 20-year planning horizon, 60% of the useful life remains. This monetized benefit is approximately \$10.2 million in 2019 \$. At a 7% discounted rate of 2019\$, the benefit will amount to \$1.7 million. Note that in this section, all benefit figures are represented in 2019\$.

6.1.2 State of Good Repair

The project will reconstruct the corridor with concrete panels. If the roadway is not rebuilt, it will need to be maintained throughout the planning horizon. In addition to maintenance and rehabilitation costs incurred, users would incur increased operating costs on their vehicles due to the deteriorating pavement condition and added travel time costs owing to increased vehicular congestion. Overall, the Build Scenario is preferable to No-Build on the merits of savings under life cycle costs, maintenance, and user costs. Accumulated benefits yield approximately \$1.45 million in monetized benefits over the 20-year planning horizon. At a 7% discount rate, the benefit will amount to \$ 451,000.

6.1.3 Value of Time Travelled

The vehicular traffic along the corridor is projected to rise through the planning horizon. The Project will modernize intersections, add turn lanes and widen travel lanes. This improvement will reduce the travel time over the No-Build Scenario. The resulting reduction in travel time will save users money, valued at \$17.90 per hour for cars at a vehicle occupancy of 1.67 persons per vehicle. The total monetized benefit over the 20-year planning horizon is approximately \$5.5 million. At a 7% discounted rate, the benefit will amount to \$1.2 Million.

6.1.4 Safety Benefits

The Project will improve safety along the Project corridor by reducing the number of vehicular crashes. The benefits are derived from the reduced human-affecting injury and property damages. A total of 100 crashes occurred from 2017 to 2021 along this corridor. Adding a left-turn lane along the corridor and proposed traffic signal improvements will reduce related crashes by up to 28%. The total monetized benefit over the 20-year planning horizon is approximately \$ 2.1 Million. At a 7% discounted rate, the benefit will amount to \$1.01 Million.

6.1.5 New Pedestrian Users & VMT Reduced

Adding sidewalks complete with ADA-compliant ramps, and crossings will induce additional pedestrian activity around the corridor. In a No Build scenario, the newly generated pedestrian activity would have been traversed using a vehicle. The 2018 H-GAC TDF predicts approximately 359 daily internal automobile trips within the Project area. The Project will result in 27% of these trips converting from automobile to new



pedestrian daily trips^{18 19}, resulting in 90 to 100 new pedestrian daily trips in the Build Scenario. These new daily pedestrian trips will yield an annual VMT reduction of 21,900, which has various benefits.

6.1.6 Auto Costs

Operating a vehicle is one of the most expensive budget items in American households—the reduction in VMT from automobile trips converted to pedestrian results in a benefit for automobile owners. Improved roadway conditions also mean lower automobile wear and tear, which translates into auto-operational cost savings and fuel costs savings. Auto benefits are tabulated under two headers- pedestrian reduced auto use and fuel benefits.

6.1.6.1 Pedestrian reduced Auto Use benefit

In the no-build scenario, the Airport Road surface continues to be of asphalt with cracks and damages the vehicles. The build scenario will reconstruct the roadway using concrete panels, providing a smoother surface for cars. The 2021 USDOT BCA Resource Guide estimates the cost of automobile operation as 43 cents (\$2019) per mile. The value per mile includes operating costs, such as gasoline, maintenance, and depreciation. The benefit omits fixed costs of owning a vehicle, such as insurance and registration. The total automobile maintenance avoided by reducing VMT yields a net benefit of \$380,000. At a 7% discount rate\$, the benefit will amount to \$121,000.

6.1.6.2 Auto Fuel Benefits

Modernizing intersections and widening the Airport Road corridor will reduce travel time and fuel consumed. The Synchro microsimulation projects had 2,360 gallons of fuel reduced because of the operational improvements throughout the planning horizon. The average fuel per gallon in 2019 was \$2.36, less the fuel tax of \$0.38, which provides a net cost per gallon of \$1.98. Accumulated auto fuel savings from reduced idling amount to \$ 919,000. At a 7% discount rate , this will equal \$259,000.

6.1.7 Environmental Benefits

The EPA has classified the Houston-Galveston-Brazoria area in marginal nonattainment of the eight-hour ozone standard; air quality does not meet federal standards.²⁰ The investment in mobility infrastructure could produce environmental benefits due to decreased automobile use or vehicle delay which will reduce air pollutants, which is important to the region’s future growth. Environmental benefits are tabulated under two headers- reduced NOx emissions based on reduced VMT, and reduced NOx emissions based on reduced vehicle idling.

¹⁸ Ewing, R., Greenwald, M. J., Zhang, M., et. al. (2009). *Measuring the Impact of Urban Form and Transit Access on Mixed Use Site Trip Generation Rates -- Portland Pilot Study*. Washington, D.C.: U.S. Environmental Protection Agency.

¹⁹ Handy, S. et al. (2014). *Impacts of Pedestrian Strategies on Passenger Vehicle Use and Greenhouse Gas Emissions - Policy Brief and Technical Background Document*. California Air Resources Board. Retrieved from: <https://arb.ca.gov/cc/sb375/policies/policies.html>

²⁰ *8-Hour Ozone (2015) Nonattainment Area State/Area/County Report | Green Book | US EPA. (2021)*. <https://www3.epa.gov/Airquality/Greenbook/Jncs.html#TX>. Retrieved September 2021, from <https://www3.epa.gov/airquality/greenbook/jncs.html#TX>



6.1.7.1 Reduced NO_x emissions on basis of reduced VMT

For sidewalk improvements that enhance walkability, the environmental benefits accumulate from automobile trips being converted into pedestrian trips. The VMT benefit (described in the Auto Costs section) is derived and converted into the amount of NO_x grams reduced, which is then monetized based on the H-GAC emissions factor. VMT is assumed to grow annually at the same rate as internal trips. Accumulated benefits amount to \$19,000. At a 7% discount rate, this will equal \$11,000.

6.1.7.2 Reduced NO_x emissions on basis of reduced idling

Modernizing intersections and widening the Airport Road corridor reduces vehicle idling, generating savings on fuel consumed. The optimized fuel consumption yields reduced NO_x emissions resulting in societal benefits of \$314,000. At a 7% discount rate, this will equal \$89,000.

6.1.8 Local Economic Benefits

Benefits Monetized but Not Widely Accepted in Transportation Grant Applications

Accessible pedestrian facilities can spur increased property values, resulting in increased appraisal values that provide additional property tax benefits to the study area. Research has shown that walkability improvements can increase the property values of residential²¹ and commercial properties.²² Empirical evidence adjusted to the corridor context shows that the residential property values can go up by \$4,672 per property and commercial property values can hike up by 9%. Benefits are only attributed to the increment for each property. Net local economic benefits add up to \$411,000. At a 7% discount rate, this will equal \$151,000.

²¹ Liu, J. H., & Shi, W. (2017). Impact of bike facilities on residential property prices. *Transportation research record*, 2662(1), 50-58.

²² The University of Delaware. *Healthy and complete communities in Delaware: The walkability assessment tool*. Retrieved in June 2017, from <http://www.ipa.udel.edu/healthyDEtoolkit/walkability/benefits.html>.



7. Existing NEPA Status

An environmental risk assessment was conducted for the Project corridor. The table below summarizes the potential for environmental risk or any “red flags” which would impact the project schedule or budget. The Airport Road Reconstruction Project is not anticipated to adversely impact anything. A moderate level of additional analysis/minor agency coordination is anticipated for the following:

Air Quality: projects that add capacity generally require a conformity analysis or an Air Quality Statement if receiving state or federal funding.

Cultural Resources: Fourteen properties potentially eligible as historic are located adjacent to the project alignment. A surface archeological survey may be required in this area.

Ecologically Sensitive Areas and Endangered and Threatened Species: Endangered and threatened species are present in Montgomery County. A moderate level of additional analysis/minor agency coordination is anticipated.

Soil: The southern portion of the alignment is in prime farmland. The north side of Airport Road in this area has been developed for commercial and residential uses. While a farmland evaluation may be required, it is not anticipated that there will be any adverse impacts requiring mitigation.

Noise: Moderate level of additional analysis/minor agency coordination may be needed due to the project increasing capacity.

A full environmental risk assessment is contained in Appendix B: Environmental Risk Assessment Airport Road Reconstruction.



Table 7 Environmental Review Summary

Airport Road Reconstruction Project Environmental Review Summary

Category	Review Summary
Land Use	No adverse impacts.
Air Quality	The project will add capacity: one lane in each direction and a center turn lane. Projects that add capacity generally require a conformity analysis or an Air Quality Statement if receiving state or federal funding.
Cultural Resources	Fourteen properties potentially eligible as historic are located adjacent to the project alignment. The project is not anticipated to adversely impact these potential resources. A surface archeological survey may be required in this area. While much of the project alignment is in an area designated by TxDOT as “No Survey Recommended,” an area in the northern end is designated as “Surface Survey Recommended, No Deep Reconnaissance Recommended.”
Hazardous Materials	The proposed project has one hazardous materials site adjacent to the alignment: Proposed Oscar J. Johnson Community Center Property, VCP Site #2830. The site withdrew from the VCP in 2016 and there is no additional information in TCEQ’s Central Registry. There are also two Superfund sites in the project vicinity: Conroe Creosoting (less than 0.5 mile away) and United Creosoting (one mile away). The project is not anticipated to adversely impact these hazardous materials sites.
Public Parks and Recreation Areas	No adverse impacts.
Population Characteristics and Socioeconomics	No adverse impacts. Projects are anticipated to improve safety and mobility for area residents.
Soil	The southern portion of the alignment is in prime farmland. The north side of Airport Road in this area has been developed with commercial and residential uses. The south side is undeveloped and not used for agricultural purposes, and some areas are designated for commercial uses. While a farmland evaluation may be required, it is not anticipated that there will be any adverse impacts requiring mitigation.
Wetlands	The project is adjacent to a wetland area between G&G Marine and Iglesia de Dios Pentecostal. The area is used as a soccer field. No excavation, placement of fill materials, or other alterations or construction are proposed for the wetland areas; therefore, no adverse permanent impacts are anticipated to wetlands.
Floodplains	No adverse impacts.
Waters of the U.S.	No adverse impacts.
Water Quality, Navigable Waterways, and the Coastal Zone	No adverse impacts.



Ecologically Sensitive Areas and Endangered and Threatened Species	Endangered and threatened species are present in Montgomery County; the proposed project is not anticipated to adversely impact habitat. A moderate level of additional analysis/minor agency coordination anticipated.
Migratory Birds	No adverse impacts.
Right-of-Way and Acquisition	No adverse impacts.
Traffic and Parking	No adverse impacts.
Noise	No adverse impacts. Moderate level of additional analysis/minor agency coordination may be needed due to project increasing capacity.
Safety and Security	No adverse impacts.
Aesthetics	No adverse impacts.
Construction Impacts	No adverse impacts.

INDEX OF SHEETS
SHEET NO. DESCRIPTION

- 1 TITLE SHEET
- 2 DIVISION MAP
- 3 DRAINAGE AREAS & HAUL DIAG.
- 4-6 PLAN PROFILE SHEETS
- 7-15 STRUCTURAL STANDARDS
- 7-15 W-17-6 MODIFIED
- 8-MBC-124-F
- 9-MBC-9
- 10-NC-7
- 11-CH-6
- 12-S-2
- 13-W-1
- 14-SWC-1
- 15-BARRICADES & WARNING SIGNS
- 16-18 HAUL VIA GRADES
- 19-21 REVIEW CROSS SECTIONS
- 22-26 CHANNEL CROSS SECTIONS
- 27-31 CROSS SECTIONS

STATE HIGHWAY DEPARTMENT OF TEXAS
PLANS OF PROPOSED IMPROVEMENT
U.S. WORKS PROGRAM HIGHWAY PROJECT
NO. WPSO 898 A

MONTGOMERY COUNTY
NET LENGTH PROJECT = 26,320.75 FT. = 5.363 MI.
FROM CITY LIMITS OF CONROE TO INTERSECTION
WITH WILLIS-CUT AND SHOOT ROAD

NCTE: The contractor shall provide and maintain at his entire expense, during and approaches where the proposed improvement follows or crosses any existing road or private cartway, any other road used as a detour shall be maintained by the county.

EQUATIONS: 12 equations, totaling 211 feet net decrease in length. See list of equations on plan profile sheet No. 6. NO GRADE CROSSINGS ELIMINATED. NO EXCEPTIONS.

STA. 206+24.0 Control 1417-1-1
END U.S. HWY PROJ. NO. W.P.S.O. 898 A
ADJOINING PROJ. UNIMPROVED

DELIVERY POINTS FOR MATERIAL
RAILROAD DEL. POINT CONROE
DISTANCE FROM PROPOSED PROJECT 1 MILE
CAR CAPACITY AMPLE

STATE HIGHWAY NO. 105
SPECIFICATIONS APPROVED BY THE CHIEF OF THE U.S. BUREAU OF PUBLIC ROADS, FEBRUARY 1936, AND SPECIFICATION ITEMS SUBSEQUENTLY APPROVED, LISTED AND DATED AS FOLLOWS, SHALL GOVERN IN THEIR REVERSE CHRONOLOGICAL ORDER:

RECOMMENDED FOR ADOPTION	RECOMMENDED FOR ADOPTION	RECOMMENDED FOR ADOPTION	RECOMMENDED FOR ADOPTION
1	2	3	4
5	6	7	8
9	10	11	12
13	14	15	16
17	18	19	20
21	22	23	24
25	26	27	28
29	30	31	32
33	34	35	36
37	38	39	40
41	42	43	44
45	46	47	48
49	50	51	52
53	54	55	56
57	58	59	60
61	62	63	64
65	66	67	68
69	70	71	72
73	74	75	76
77	78	79	80
81	82	83	84
85	86	87	88
89	90	91	92
93	94	95	96
97	98	99	100

STA. 22+82.15 Control 1417-1-1
BEGIN U.S. HWY PROJ. NO. W.P.S.O. 898 A
NOTE: FEDERAL PROJECT MARKERS OF APPROVED DESIGN WILL BE ERRECTED AT EACH END OF PROJECT PRIOR TO COMPLETION APPROVED NOV. 1, 1936.
REQUIRE SPECIAL PROVISIONS FOR WORKS PROGRAM HIGHWAY AND GRADE CROSSING PROJECTS, APPROVED SEPT. 30, 1935.

LAYOUT SCALE: 1 IN. = 52.80 FT.

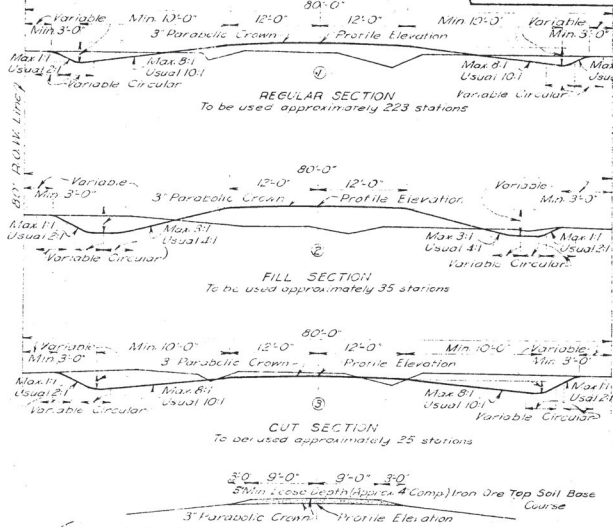

GENERAL NOTES:
In those instances where final features require the governing slope indicated herein, may be varied from between the limits and to the extent determined by the Engineer. Final measurements are to be by actual built and in accordance with item 1115 of the specifications.
Curves to be super-elevated and widened in accordance with State Highway Department Standard SWC-1 attached herewith or as directed by the Engineer.

IRON ORE TOP SOIL BASE COURSE NOTES:
Iron ore gravel shall be placed in one course of 3" loose depth approximately 4" compacted depth.
Attention is directed to the fact that typical Section No. 1, 2, & 3 shall conform accurately to the various items of Excavation and Embankment. The roadbed shall be graded to conform accurately to the typical Cross Sections and to the lines and elevations established by the Engineer.

WPSO 898-A
1417-1-1
M-1605

SUMMARY OF GRADING AND SURFACING

SHEET NO.	STATIONS	CLEARING & GRUBBING ACRES	COMMON ROAD EXC. CU YDS.	COMMON CHAN EXC. CU YDS.	STATION HAUL STA. YDS.	QUARTER HAUL YD. QTRS.	BLADING EMBANK. HRS.	IRON ORE TOP SOIL BASE COURSE CU YDS.	GRAVEL HLD. ADD. 1/2 MILE CU YDS.	IRON ORE TOP SOIL BASE COURSE CU YDS.	STRIPPING CU YDS.
4	22+82.15-146+100	13.38	11686	7653	9186	47	123	4014	8026	200	
5	146+00-274+00	12.65	12048	1747	6392	449	126	4203	10346	500	
6	274+00-306+24	2.89	3972	0	1869	10	32	1046	96	300	
TOTALS		28.92	27406	9400	17447	506	263	9281	19318	1000	

SUMMARY OF DRAINAGE STRUCTURES
STRUCTURES LESS THAN 20 FOOT SPAN

PLAN PROFILE SHEET	STATION	SIZE	DESIGN	DESCRIPTION	UNCL. EXCAVATION CU YDS.	CLASS. CONC. CU YDS.	REINFORCING STEEL LBS.	CORR. GRVL. METAL PIPE 30" DIA. X 30' DIA. LIN. FT. LBS. FT.	RELAYING CULVERT PIPE (BY DIAM.) LIN. FT.
4	47+76	3'-2" x 24"	NC-7	Conc. Box Culk	17	7.9	610		
4	60+00	3'-18" x 25'4"	CH-6	Corr. Pipe & Holes	8	2.26	92		76
4	76+42	8'-2" x 24"	NC-7	Conc. Box Culk	34	21.73	1993		
4	107+06	24" x 26" 0"	CH-6	Corr. Galv. M. Pipe	7	1.60	78	26	
5	149+15	3'-2" x 24"	NC-7	Conc. Box Culk	11	7.5	610		
5	202+12	3'-2" x 24"	NC-7	"	14	7.9	610		
5	211+05	4'-0" x 24"	MBC-9	Mult. Conc. Culk	20	34.2	3942		
5	226+30	8'-5" x 24"	NC-7	Conc. Box Culk	118	33.63	2799		
5	258+00	5'-3" x 24"	NC-7	"	36	14.87	1318		
6	277+82	30" x 28" 0"	CH-6	Corr. Galv. M. Pipe	16	2.20	102	28	
6	295+60	5'-3" x 24"	NC-7	Conc. Box Culk	53	16.42	1454		
TOTALS					336	150.81	13608	26	76

STRUCTURES OVER 20 FOOT SPAN

PLAN PROFILE SHEET NO.	STATIONS	LENGTH FEET	DESIGN	DESCRIPTION	UNCL. EXCAVATION CU YDS.	CLASS. CONC. CU YDS.	REINFORCING STEEL LBS.	TIMBER PILING UNTRTD. TYP. 12" DIA. EACH LIN. FT.	TREATED TIMBER 12" x 6" M.F.B.M. EACH LIN. FT.	UNTREATED TIMBER 12" x 6" M.F.B.M. EACH LIN. FT.	TIMBER PILE SUNK IN PLACE EACH
4	26+10-27+01.50	91'6"	W-16	Multi-Span Tr. Timb. Pile	15			* 2	1020	5615	5907
4	28+20-29+51.50	31'6"	"	"	15			* 1	600	4835	2056
5	172+35-172+57.50	22'15"	MBC-124	4'-5" x 24" Mult. Conc. Culk	22	43.64	3364	* 3	1620	14450	7963
TOTALS					52	43.64	3364				3

* Test Piling 35' long

ESTIMATE SUMMARY

During construction, the necessary adjustment to roadway grade or culvert flow line will be made to provide the depth of fill over pipe culverts as required in the pertinent specifications.

NOTE: The quantity for Common Road Excavation is approximate and it is hereby provided that the usual 20% variation clause covered in Specification Item 4.3 be amended to permit a variation of 35% for this item.

ITEM	DESCRIPTION	GRADING, SURFACING, SMALL DRAINAGE STRUCTURES	QUANTITIES		UNIT
			ESTIMATED	FINAL	
10	Clearing & Grubbing	28.92	28.92	19.58	Acre
11	Common Road Excavation	27406	27406	27619	Cu Yd
12	Common Channel Excavation	9400	9400	7261	Cu Yd
13	Station Haul	17447	17447	32400	Sta Yd
14	Quarter Haul	506	506	377	Yd Qtr
15	Blading Embankment	263	263	101	Hour
Sp	Iron Ore Top Soil Base Course	9281	9281	7970	Cu Yd
Sp	Material for road & Mile	19318	19318	24172.5	Cu Yd
17	Stripping	1000	1000	0.0	Cu Yd
Sp	Unclassified Str. Exca. (Culverts)	336	336	257.9	Cu Yd
Sp	Class 2 Concrete	150.81	43.81	194.86	Cu Yd
Sp	Reinforcing Steel	13608	5364	18972	Lbs
Sp	Corr. Galv. Metal Pipe 24" Diam.	16	16	28	Lin Ft
Sp	Corr. Galv. Metal Pipe 30" Diam.	28	28	28	Lin Ft
Sp	Relaying Culvert Pipe (18" Dia. Under)	76	76	76	Lin Ft
Sp	Unclassified Str. Exca. (Bridges)	30	30	0.0	Cu Yd
Sp	Untreated Timber Test Piling	3	3	3	Each
Sp	Treated Timber Piling (6" x 6")	1620	1620	1879.67	Lin Ft
Sp	Treated Timber (12" x 6")	14450	14450	14404	M.F.B.M.
Sp	Untreated Timber	7963	7963	7.653	M.F.B.M.
Sp	Timber Pile Splice Type-S2	3	3	0.0	Each
Sp	Removing Old Structures	10	10	10	Each

GENERAL NOTES: STRUCTURES TO BE REMOVED BY THE CONTRACTOR AT UNIT CONTRACT PRICE. Markers M-1, shall be provided for all small structures in this project. The burning and razing of grass and weeds will be considered as incidental to contract items and no direct compensation will be made for this work.

NOTE: The contractor will be required to provide a total of not less than 8 man hours of employment in accordance with the provisions of the specifications and the special provisions.

ESTIMATE & QUANTITY SHEET